



© 2023. The Author(s). This is an open-access article distributed under the terms of the Creative Commons Attribution-ShareAlike 4.0 International Public License (CC BY SA 4.0, <https://creativecommons.org/licenses/by-sa/4.0/legalcode>), which permits use, distribution, and reproduction in any medium, provided that the article is properly cited.

Effect of the type of amino acid on the biodegradation of ibuprofen derivatives

Paula Elżbieta Ossowicz-Rupniewska*, Edyta Kucharska,
Joanna Kleboko, Ewelina Kopciuch, Karolina Bilska, Ewa Janus

Department of Chemical Organic Technology and Polymeric Materials,
West Pomeranian University of Technology in Szczecin, Poland

* Corresponding author's e-mail: possowicz@zut.edu.pl

Keywords: biodegradability; ibuprofen; amino acids isopropyl ester ibuprofenates; metabolites; nonsteroidal anti-inflammatory drug

Abstract: Water pollution caused by anthropogenic activity is a huge environmental problem. Huge amounts of consumed medicinal substances cause them to get into the environment. Non-steroidal anti-inflammatory drugs, including ibuprofen, are one of the most popular drugs in the world. This article presents the biodegradation of ibuprofen and isopropyl ester salts of various amino acids. Twelve ibuprofen isopropyl esters of L-amino acids were used in the research. The obtained derivatives may be a safer and more effective alternative to ibuprofen. Biodegradation tests were carried out using activated sludge. Sewage sludge was obtained from the local sewage treatment plant in Szczecin "Pomorzany". Ibuprofen derivatives, ibuprofenates of isopropyl amino acid esters, were used for the tests. It was checked how the type of structural modification of ibuprofen affects the biodegradation of the drug used. In this publication, it was verified how the type of amino acid affects biodegradation. Our evaluation of the biodegradation of ibuprofen derivatives by bacterial cultures revealed that six compounds are attractive carbon and energy sources for the active material utilized. These compounds were readily biodegradable within 28 days. There were no straightforward relationships between the structure, properties, and biodegradability of the obtained derivatives.

Introduction

Due to the bioactive nature of drugs and their toxic metabolites, it is believed that drugs in aquatic environments pose a greater threat to the environment and water quality than any other pollutant (Hashem et al. 2023). Ibuprofen is the third most popular, highly prescribed, and most widely sold nonprescription drug in the world, and its concentration in water bodies is increasing day by day as a result of increased consumption caused by population pressure (Kamal et al. 2023). Approximately 15% of an oral dose of ibuprofen is excreted by humans as unchanged molecules (conjugated with glucuronide and thiol) as well as its metabolites carboxyibuprofen, hydroxyibuprofen, and carboxyhydratropic acid. Ibuprofen conjugates are hydrolyzed further in the environment (Khasawneh et al. 2023, Jan-Roblero and Cruz-Maya 2023).

The ecotoxicology of 26 pharmaceuticals in aquatic systems in Spain was investigated to determine the environmental risk posed by these active compounds. Ciprofloxacin, acetaminophen, clofibrate, ibuprofen, clarithromycin, triclosan, parabens, omeprazole, and 1,4-benzoquinone were found to pose a risk to aquatic environments. Ibuprofen

concentrations in the environment have increased as a result of anthropogenic activity. After human consumption, ibuprofen is not completely metabolized and is excreted, whereas the toxicity of its metabolites exceeds that of its parent molecule (Collivignarelli et al. 2023, Hawash et al. 2023). To determine acute and chronic toxicity, the toxicology study focuses on daphnia and fish. This enables the determination of its no-observed effect concentration (NOEC), which is then used to compute its predicted no-effect concentration (PNEC). The estimated risk ratio for ibuprofen was less than one, indicating it was an environmentally hazardous substance (Riva et al. 2019). Studies have shown that pharmaceuticals decrease fish spawning and simultaneously increase the number of eggs in *Oryzias latipes*, Japanese medaka. It also disrupted the endocrine system of *Mytilus galloprovincialis* at modest concentrations. In addition, its presence led to the development of antioxidative stress. After exposure (within 7 days), it also increased the activity of catalase, superoxide dismutase, phase II glutathione S-transferase, and glutathione reductase. In mussels, membrane degradation in the digestive organ and increased lipid peroxidation were observed. At a concentration of 11.5 g/L, a reduction of genes harmed aerobic respiration, skeletal development, and immune function, whereas, at larger

concentrations, expression of arachidonic acid metabolism pathway regulatory genes and inflammatory response immune genes increased (Preglo et al. 2023, Lohmann and Dachs 2010).

The acute toxicity of pharmaceutical pollutants present in water bodies (including ibuprofen) is determined by the short-term EC_{50} (10 and 100 mg/L), and the cyto- and genotoxic effects of analgesics are evaluated with prolonged exposure. Long-term exposure primarily causes an imbalance in the oxidative status of cells. Changes in growth rate, behavior, reproduction, as well as biochemical alterations are observed in aquatic organisms. Ibuprofen-diacylglycerol (ibuprofen-DG) was responsible for the inhibition of cell division and the non-disjunction of several pairs of chromosomes. Ibuprofen increased the production of 17-estradiol while decreasing testosterone production and aromatase activity. In addition, the 0.1 g/L ibuprofen concentration has caused a delay in the hatching process (Jan-Roblero and Cruz-Maya 2023, Batucan et al. 2022, Salesa et al. 2022, Chopra and Kumar 2020b, Kayani et al. 2009).

Physicochemical processes eradicate ibuprofen from the aquatic environment efficiently. Highly reactive hydroxyl radicals initiate ibuprofen oxidation. Metabolites like 4-isobutylphenol, hydratropic acid, 4-(1-carboxyethyl) benzoic acid, 4-ethylbenzaldehyde, 2-[4-(1-hydroxy-2-methylpropyl) phenyl] propanoic acid, 1-(4-isobutylphenyl)-1-ethanol, 4-acetylbenzoic acid 1-isobutyl-4-vinylbenzene and 4-isobutylacetophenon are produced during this process, which the toxicity of these metabolites exceeds that of ibuprofen (Chopra and Kumar 2020b, Marchlewicz et al. 2017, Żur et al. 2018).

Many toxicological studies found that the intermediates formed during conventional removing them from the aquatic environment were more toxic than parent compounds. Therefore, the proposed method of aerobic biodegradation of ibuprofen and its derivatives (economic and natural process) is seen as a future alternative for the removal of pharmaceuticals from waterbodies. Aquatic microorganisms used ibuprofen and its derivatives as a carbon and energy source. Biological treatment is considered an important method for pollutant removal. But they are characterized by some disadvantages, such as some pharmaceuticals having lower susceptibility rates during biodegradation; intermediates produced during biodegradation having a more toxic impact on the system than their parent molecule; though many microorganisms are having the capability to use the pharmaceuticals as carbon and energy sources, these microorganisms are often sensitive to changes in temperature and pH (Abbot et al. 2022, Kumar and Chopra 2022, Revaprasadu and Khan 2021, Alfonso-Muniozguren et al. 2021).

Numerous studies related to activated sludge have been performed to isolate and identify microorganisms present in activated sludge in wastewater treatment plants. Gram-negative filamentous bacteria are commonly observed in activated sludge and contribute to poor settlement of activated sludge flocs in secondary sedimentation tanks. By using the morphological characters of these aquatic microorganisms, more than twenty-five types of filamentous bacteria present in sludge samples were distinguished. The important part of the gram-negative filamentous bacteria present in activated sludge are *Haliscomenobacter spp.*, *Sphaerotilus spp.*, *Leptothrix spp.*, *Thiothrix spp.*, and *Leucothrix mucor* (Wagner et al. 1994, Conco 2016, Conco et al. 2018, Zhang et al. 2019).

Depending on the environmental conditions, the microorganisms present in activated sludge have a variable morphology. Identified the following filamentous bacteria, such as *Haliscomenobacter hydrossis*, *Sphaerotilus natans* and *Microthrix parvicella*, which have nonfilamentous growth forms. At the same time, a member of the cytophaga-flavobacterium cluster (*Haliscomenobacter spp.*) belongs to thin filamentous bacteria. They commonly occurred inside the sludge flocs drawn from the sewage treatment plant, but they were almost undetectable in thick sludge flocs without a specific staining reaction. In activated sludge samples, the presence of large coccoid cells, by hybridisation of activated sludge samples with fluorescein-labeled probe TNI and rhodamin-labeled). These coccoid cells may represent the ovoid structures "gonidia" described for *Thiothrix spp.*, *Leucothrix mucor*. In situ hybridisation proved the simultaneous presence of *Thiothrix spp.* and type 21N bacteria in three of the ten examined activated sludge samples. In the sample of the industrial wastewater treatment plant (Hoechst, Augsburg, Germany), *Thiothrix spp.* was found to be a dominant component of the microbial community and the only filamentous bacterium present. It is likely responsible for the sludge bulking observed at the time of sampling (Conco et al. 2018, Zhang et al. 2019, Chen et al. 2022, Hamiruddin and Awang 2021).

Few investigations have been published on the ibuprofen-degrading purified bacterial cultures isolated from activated sludge and effluent. Presently, little is also known about the metabolites produced during ibuprofen's biodegradation. Few pure isolates with the ability to degrade ibuprofen have been identified: *Bacillus thuringiensis* B1(2015b), *Nocardia sp.* NRRL 5646, *Sphingomonas Ibu-2*, and *Patulibacter sp.* strain I11. Some microorganisms are able to degrade ibuprofen in the presence of tryptone, yeast extract or glucose. Enzyme induction is essential for the biodegradation of ibuprofen by isolated strains because degradation is dependent on the ability of microbes to produce an ibuprofen-degrading specific enzyme (Marchlewicz et al. 2017, Kumar and Chopra 2022, Chopra and Kumar 2022).

Our previous publications described the synthesis, properties, skin penetration, and skin accumulation of L-amino acid alkyl ester ibuprofenates, new ibuprofen derivatives. It has been demonstrated that these compounds have a much higher solubility in water and body fluids and a higher skin permeability than ibuprofen, making them a viable alternative (Janus et al. 2020, Ossowicz et al. 2020, Ossowicz-Rupniewska et al. 2021, Ossowicz-Rupniewska et al. 2022a, Ossowicz-Rupniewska et al. 2022b, Ossowicz-Rupniewska et al. 2022c, Kleboko et al. 2022, Kleboko et al. 2023). In addition, it was shown that the obtained salts of amino acid alkyl esters did not lead increased toxicity to selected cell lines compared to unmodified NSAIDs. It was found that amino acid alkyl ester ibuprofenates [AAOR][IBU] showed no significant toxic effects on the human keratinocyte (HaCaT) cell line and the mouse 3T3 fibroblast cell line. Cytotoxicity studies and evaluation of the thermodynamics of the process of binding ibuprofenates of alkyl amino acid esters to bovine serum albumin are in the same range as for ibuprofen, which suggests a similar pharmacokinetic profile of the obtained derivatives. Slight differences in the binding stoichiometry and affinity constants for BSA within the series of derivatives are

probably due to the binding of cations preferably to a different binding site or different effectiveness of interactions within the same binding site (Ossowicz-Rupniewska et al. 2022a). Due to the numerous benefits of these compounds, it was decided to examine their impact on the environment by comparing the acidic-ibuprofen form to its organic salt, ibuprofenate amino acid alkyl ester. The effect of the structure of the organic cation, specifically the length of the alkyl chain, on the biodegradation process of these compounds was previously determined (Makuch et al. 2021).

This study examines the biodegradation of ibuprofen and numerous amino acid isopropyl ester salts. In the investigation, twelve ibuprofen isopropyl esters of L-amino acids were utilised. The novelty of this work lies in its comprehensive investigation of the biodegradation of ibuprofen and its derivatives and the assessment of their environmental impact. The study focuses on the biodegradation of ibuprofen by purified bacterial cultures isolated from activated sludge and effluent. This area of research seems to be relatively unexplored, with limited investigations published on the subject. It was determined how the type of structural modification of ibuprofen influences the drug's biodegradation. This study confirmed the effect of amino acid type on biodegradation. The work delves into the environmental impact of these novel ibuprofen derivatives by comparing the acidic ibuprofen form to its organic salt, ibuprofenate amino acid alkyl ester. Moreover, the study examines how structural modifications of ibuprofen, particularly the incorporation of different amino acids and alkyl chains, affect its biodegradation. This provides insights into how chemical modifications can impact the environmental fate of pharmaceutical compounds. The research also explores the influence of the type of amino acid used in the structural modification on the biodegradation process. This helps in understanding how specific amino acids may affect the environmental persistence of the compound.

Materials and Methods

Materials

All used chemicals were commercially available and did not require purification prior to use. Potassium dihydrogen phosphate (KH_2PO_4), dipotassium hydrogen phosphate (K_2HPO_4), sodium phosphate dibasic dihydrate ($\text{Na}_2\text{HPO}_4 \cdot 2\text{H}_2\text{O}$), ammonium chloride (NH_4Cl), magnesium(II) sulfate heptahydrate ($\text{MgSO}_4 \cdot 7\text{H}_2\text{O}$), calcium chloride dihydrate ($\text{CaCl}_2 \cdot 2\text{H}_2\text{O}$), potassium hydroxide (KOH), sodium hydroxide (NaOH), barium hydroxide ($\text{Ba}(\text{OH})_2$), hydrochloric acid (HCl), and iron (III) chloride hexahydrate ($\text{FeCl}_3 \cdot 6\text{H}_2\text{O}$) were purchased from Chempur, (Piekary Śląskie, Poland). Formic acid (98–100% for HPLC LiChropur™) was purchased by Supelco. Acetonitrile (for HPLC, gradient grade, $\geq 99.9\%$) was provided by Sigma-Aldrich.

Sodium dodecyl sulfate (SDS, Sigma-Aldrich, $\geq 99.0\%$) is a commonly used chemical in biodegradation tests, particularly in assessing the biodegradability of organic compounds. This compound was used as a reference and positive control.

All ibuprofen derivatives were obtained according to the method described in the previous publication (Ossowicz-Rupniewska et al. 2022c). Figure 1 shows the general structure of the amino acid alkyl ester ibuprofenates used in the study.

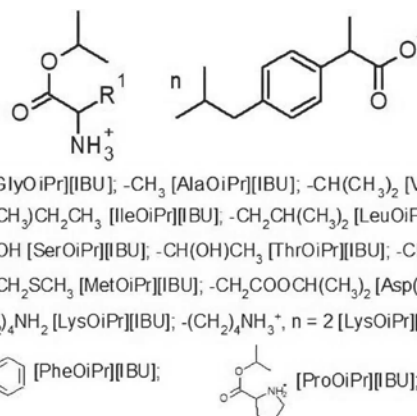

Figure 1. The general structure of ibuprofen derivatives used in this study.

Elemental Analysis

The CHNS/O elemental analysis was conducted using a Thermo Scientific™ FLASH 2000 CHNS/O Analyzer (Waltham, Massachusetts, United States). Compounds were weighed with an accuracy of 0.000001 g in tin crucibles (2–3 mg) for CHNS mode analysis and silver crucibles (1–2 mg) for oxygen mode analysis. In order to calibrate the device in CHNS mode, 2,5-(Bis(5-tert-butyl-2-benzoxazol-2-yl) thiophene (BBOT), sulfanilamide, L-cysteine, and L-methionine were used as standards. The oxygen mode utilised acetanilide and benzoic acid.

The test medium

The test medium was prepared through the addition of the following solutions (per litre): 10 mL of solution 1 (adjusted to pH 7.4): 8.50 g of KH_2PO_4 , 21.75 g of K_2HPO_4 , 33.40 g of $\text{Na}_2\text{HPO}_4 \cdot 2\text{H}_2\text{O}$ and 0.50 g of NH_4Cl ; 1 mL of solution 2): 22.50 g of $\text{MgSO}_4 \cdot 7\text{H}_2\text{O}$; 1 mL of solution 3): 36.40 g of $\text{CaCl}_2 \cdot 2\text{H}_2\text{O}$; and 1 mL of solution 4): 0.25 g of $\text{FeCl}_3 \cdot 6\text{H}_2\text{O}$.

Origin of samples of active sludge

First, the active sludge samples have been collected from the aeration chamber of the sewage treatment facility Pomorzany in Szczecin. The samples were subsequently aerated and stored until use. The concentration of active sludge suspensions was subjected to a microbiological assay (Schulke Mikrocount Duo) to determine the total number of microorganisms (CFU per 1 mL of active sludge). A microbiological test containing medium and TTC agar with Tergitol-7 (triphenyl tetrazolium chloride, according to ISO 9308) was immersed in an active sludge for 10 seconds. After 96 hours at room temperature, the number of bacteria was determined by comparing the test's appearance to that of a standard test (Figure 2).

The Microbial Challenge Test was performed according to the procedure described in the following publication (Adejokun & Dodou 2020). The microbial challenge test was performed using Schulke+ mikrocount® duo dipslides containing two agar surfaces (the yellow agar surface promotes bacteria growth, i.e., *Staphylococcus spp* or *Escherichia coli*, while the pink agar surface promotes yeast and fungi growth). The yellow surface of the agar was immersed in the test sample of activated sludge. The slide was then enclosed and left for 72 h to allow optimum bacteria growth. All measurements were done at room temperature 25 ± 1 °C and a humidity of 33%.

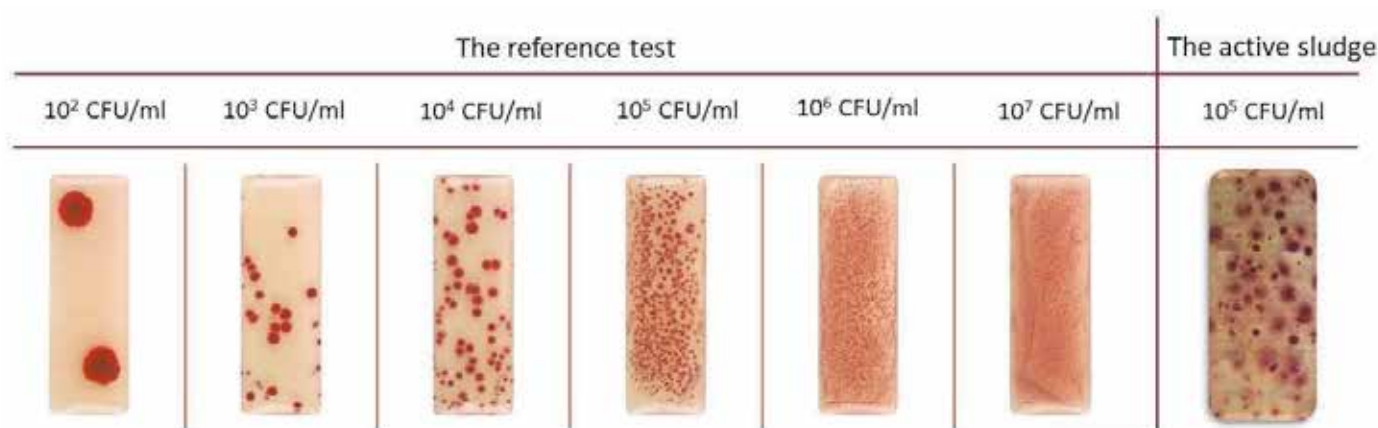

Figure 2. The appearance of the test obtained after immersion of the insert in the active sludge – rights, the appearance of the reference test - left.

The density of the colony formed on the nutrient plate is determined using the colony density charts specified by Schulke. After 72 h, microbial growth was observed for the 10 activated sludge samples tested. Activated sludge samples tested, in reference to the colony density, as shown in Figure 2, had 10^5 CFU/mL activated sludge.

In addition, the experimental method in the agar medium determined the total number of microorganisms on 1 mL of activated sludge ($0.96 \cdot 10^5$ CFU/mL) (Nowak et al. 2022). The lactose Tergitol 7 TTC agar (Merck Millipore) medium was used for bacterial cultivation. The medium (20 mL) was poured into Petri dishes with a diameter of 90 mm. After the medium had solidified 1 mL (1000-fold diluted in PBS) of activated sludge was added. The inoculum was evenly spread over the surface of the medium. The inoculum was evenly spread over the surface of the medium. The slide was then enclosed and left for 72 h to allow optimum bacteria growth. All measurements were done at room temperature 37 ± 1 °C. The results after 72 h were used for final analyses. After this time, the number of bacterial colonies was calculated, which ranged from 94 to 98. The studies showed that the density of the bacterial cultures ranged from 0.94 - $0.98 \cdot 10^5$ CFU per mL.

Method for determining the potential for aerobic biodegradation of ibuprofen derivatives

The only source of carbon and energy were organic compounds ibuprofen (IBU) and its derivatives: [GlyOiPr][IBU], [AlaOiPr][IBU], [ValOiPr][IBU], [IleOiPr][IBU], [LeuOiPr][IBU], [SerOiPr][IBU], [ThrOiPr][IBU], [CysOiPr][IBU], [MetOiPr][IBU], [Asp(OiPr)₂][IBU], [LysOiPr][IBU], [LysOiPr][IBU]₂, [PheOiPr][IBU], [ProOiPr][IBU], and SDS (sodium dodecyl sulfate as reference compound) in organic carbon concentration 40 mg/L, which were tested in triplicate, and the results were presented as mean + SD. Three tests were conducted independently (in three measuring vessels).

Figure 3 presents the arrangement of the test vessels (1, 2, 3, 4, and 5) and the placement of a magnetic stirrer (6) connected with tubes. The test apparatus was aerated by air (I) passing through carbon dioxide (CO₂) absorbers (II and III). Air, whose velocity was controlled by a valve (IV), was routed to a carbon dioxide absorber (1), followed by a CO₂ indicator (2), to indicate the presence of carbon dioxide in the air via turbidity. 250 mL of the test medium, 2.5 mL of active sediment, and an organic compound corresponding to

40 mg/L of organic carbon were deposited in test vessel 3. The concentrations of the starting compounds were: 53.24 mg/L IBU, 59.85 mg/L [GlyOiPr][IBU], 59.16 mg/L [AlaOiPr][IBU], 57.96 mg/L [ValOiPr][IBU], 57.46 mg/L [IleOiPr][IBU], 57.45 mg/L [LeuOiPr][IBU], 61.96 mg/L [SerOiPr][IBU], 62.09 mg/L [ThrOiPr][IBU], 59.42 mg/L [CysOiPr][IBU], 63.05 mg/L [MetOiPr][IBU], 61.33 mg/L [Asp(OiPr)₂][IBU], 59.73 mg/L [LysOiPr][IBU], 57.18 mg/L [LysOiPr][IBU]₂, 61.09 mg/L [PheOiPr][IBU], 57.92 mg/L [ProOiPr][IBU], and 84.11 mg/L (SDS), respectively.

As an effect of the compound's biodegradability, vessel 3 produced carbon dioxide (CO₂), which reacted with sodium hydroxide (NaOH) to produce sodium carbonate (Na₂CO₃):

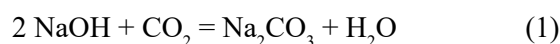

To identify the concentration of carbon dioxide in a vessel (3), 10 mL of solution from vessel (4) was transferred to a 25 mL volumetric flask. The flask was filled with deionised water to the determined maximum level. The sample was then analysed (using in triplicate) with a total organic carbon analyser by TOC-LCSH/CSN SHIMADZU CORPORATION:

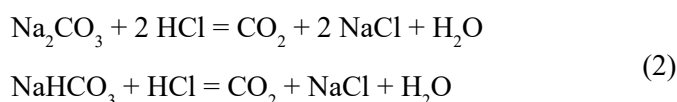

The test sample contains carbonates (Na₂CO₃) and acidic carbonates (NaHCO₃) that have been acidified with hydrochloric acid (HCl) to achieve a pH of 2-3. Na₂CO₃ and NaHCO₃ acidified with HCl are converted to CO₂. First, a calibration curve was drawn up for sodium carbonate (Na₂CO₃) and sodium bicarbonate (NaHCO₃). For this purpose, 4.415 g of Na₂CO₃ (previously dried in a muffle furnace for 2 hours using a temperature of 285°C) was introduced into a 1 L flask, and then 3.500 g of NaHCO₃ (previously dried for 2 hours over silica gel) was introduced into the flask. Finally, the flask was filled to the mark with deionised water (the water was previously boiled). From the starting solution thus prepared, dilutions of sodium carbonate and sodium bicarbonate were prepared in the concentration range of 0-100 mg/L inorganic carbon (IC) and a calibration curve was prepared. The volume of the dispensed sample was 50 µL. The calibration curve (y

= 4.1187x + 7.1718; $R^2 = 0.999$) was used to calculate the inorganic carbon (IC) concentration in the test samples.

Figure 3 shows the carbon dioxide measurement apparatus, which consisted of the following components:

- I: air with an aeration rate of 50-100 mL/min, used to aerate the all test system;
- II and III: CO₂ absorber (potassium hydroxide);
- IV: aeration rate control valve a test system;
- 1: CO₂ absorber (potassium hydroxide at 5 mol/L concentration);
- 2: CO₂ indication (barium hydroxide at 0.01 mol/L concentration);
- 3: 500 mL capacity test vessels stirred mingled with a magnetic stirrer 6;
- 4: CO₂ absorber (sodium hydroxide at 0.05 mol/L concentration);
- 5: O₂ absorber (distilled water);
- 7: container filled with distilled water, inside which test vessels a 500 mL capacity were placed and
- 8: cryostat that allows you to precisely set the temperature of the distilled water in the container. Incubation was carried out at 23 ± 0.5 °C for 28 days.

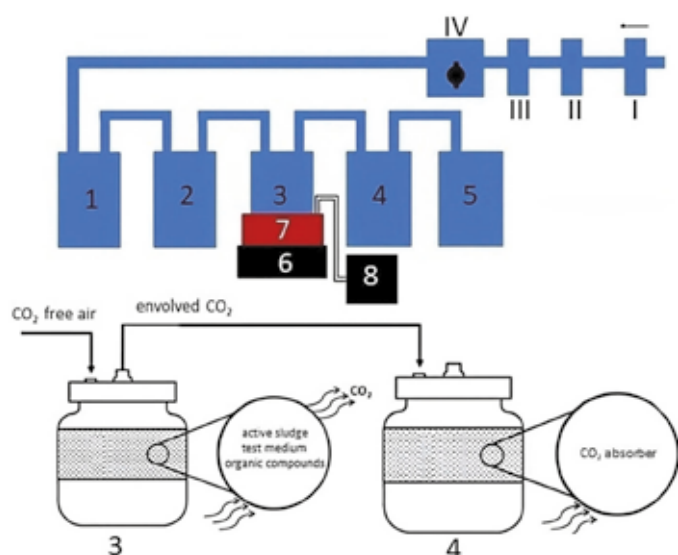

Figure 3. The test system for measuring carbon dioxide.

The biodegradation degree of the test compound was determined according to the following formula (1):

$$\%B = \frac{[C_{ICi} \cdot V_0 + \sum_{i=1}^n (C_{ICi+1} + C_{ICi}) \cdot (V_0 - i \cdot V_p)] \cdot R}{m \cdot U} \cdot 100\% \quad (1)$$

where:

%B - degree of biodegradation,

C_{IC} - concentration of inorganic carbon in the test vessel 4, obtained by TOC analysis of the test sample corrected by blank (mg/L),

R - dilution of the sample collected from the test vessel 4 (2.5),

V_0 - initial volume of NaOH solution in the test vessel 4 (0.25 L),

i - sample number,

V_p - volume of sample taken from the test vessel 4 (0.01 L),

m - mass of test compound injected into the test vessel 3 (mg),
 U - the proportion of carbon in the test compound introduced into the test vessel 3 (-).

UPLC-MS/MS method

Chromatographic separation was carried out with an Ultra-Performance liquid chromatography system (SCIEX, Framingham, MA, USA) equipped with a binary gradient pump using a Kinetex® C18 column (100 x 2.1 mm, 2.6 µm particle size, 100 Å, Phenomenex, Torrance, CA, USA). Separation was performed with a binary mobile phase at 0.5 mL/min flow rate for 0.1 min using 0.1% formic acid in water (v/v) (A) and 0.1% formic acid in acetonitrile (v/v) (B). The gradient elution was: 0–0.5 min, 98% B; 0.5–15.0 min, 2–98% B; 15.0–20.0 min, 98% B; 20.0–20.1 min, 98–2%B. The sample injection volume was 10 µL. The UPLC instrument was coupled to ZenoTOF™ 7600 System – high-resolution mass spectrometry. MS and MS/MS data were collected for each sample using Zeno IDA for optimal sensitivity on the ZenoTOF 7600 system. Data acquisition consisted of a TOF MS scan to collect accurate mass precursor ions from 100 to 840 Da and a TOF MS/MS full scan ranging from 30 to 840 Da. Data were acquired and processed using SCIEX OS software 2.1.

Results and discussions

Before beginning the biodegradation experiments, the organic carbon content was confirmed through elemental analysis. Below are the results for the carbon, hydrogen, nitrogen, sulphur, and oxygen content of the tested compounds.

Elemental analysis (%) for IBU: C 75.69, H 8.80, N 0.00, O 15.51, for [GlyOiPr][IBU]: C 66.83, H 9.04, N 4.33, O 19.80, for [AlaOiPr][IBU]: C 67.64, H 9.25, N 4.15, O 18.96, for [ValOiPr][IBU]: C 69.23, H 9.65, N 3.86, O 17.45, for [IleOiPr][IBU]: C 69.63, H 9.83, N 3.58, O 16.87, for [LeuOiPr][IBU]: C 69.61, H 9.84, N 3.59, O 16.86, for [SerOiPr][IBU]: C 64.58, H 8.83, N 3.95, O 22.64, for [ThrOiPr][IBU]: C 65.37, H 9.04, N 3.82, O 21.76, for [CysOiPr][IBU]: C 61.76, H 8.45, N 3.80, O 17.31, S 8.68, for [MetOiPr][IBU]: C 63.45, H 8.87, N 3.51, O 16.10, S 8.06, for [Asp(OiPr)₂][IBU]: C 65.23, H 8.80, N 3.32, O 22.68, for [LysOiPr][IBU]: C 66.98, H 9.72, N 7.11, O 16.23, for [LysOiPr][IBU]₂: C 69.98, H 9.38, N 4.67, O 15.99, for [PheOiPr][IBU]: C 72.62, H 8.54, N 3.36, O 15.49, and for [ProOiPr][IBU]: C 69.40, H 9.15, N 3.84, O 17.62.

The results indicate that only purified compounds were utilised in the research.

Biodegradation study

Figure 4 shows the degradation of the analysed compounds.

Table 1 shows the biodegradation of IBU, amino acid derivatives of ibuprofen and SDS (as a reference compound) by bacterial cultures.

The maximum level of biodegradation after 28 days was 65% ± 3 of ibuprofen. It is, therefore, classified as easily degradable (Figure 4). Furthermore, six modified compounds [GlyOiPr][IBU] (96%±8), [ValOiPr][IBU] (77%±1), [SerOiPr][IBU] (64%±4), [MetOiPr][IBU] (62%±2), [LysOiPr][IBU]₂ (69%±1), and [PheOiPr][IBU] (75%±2), and the reference

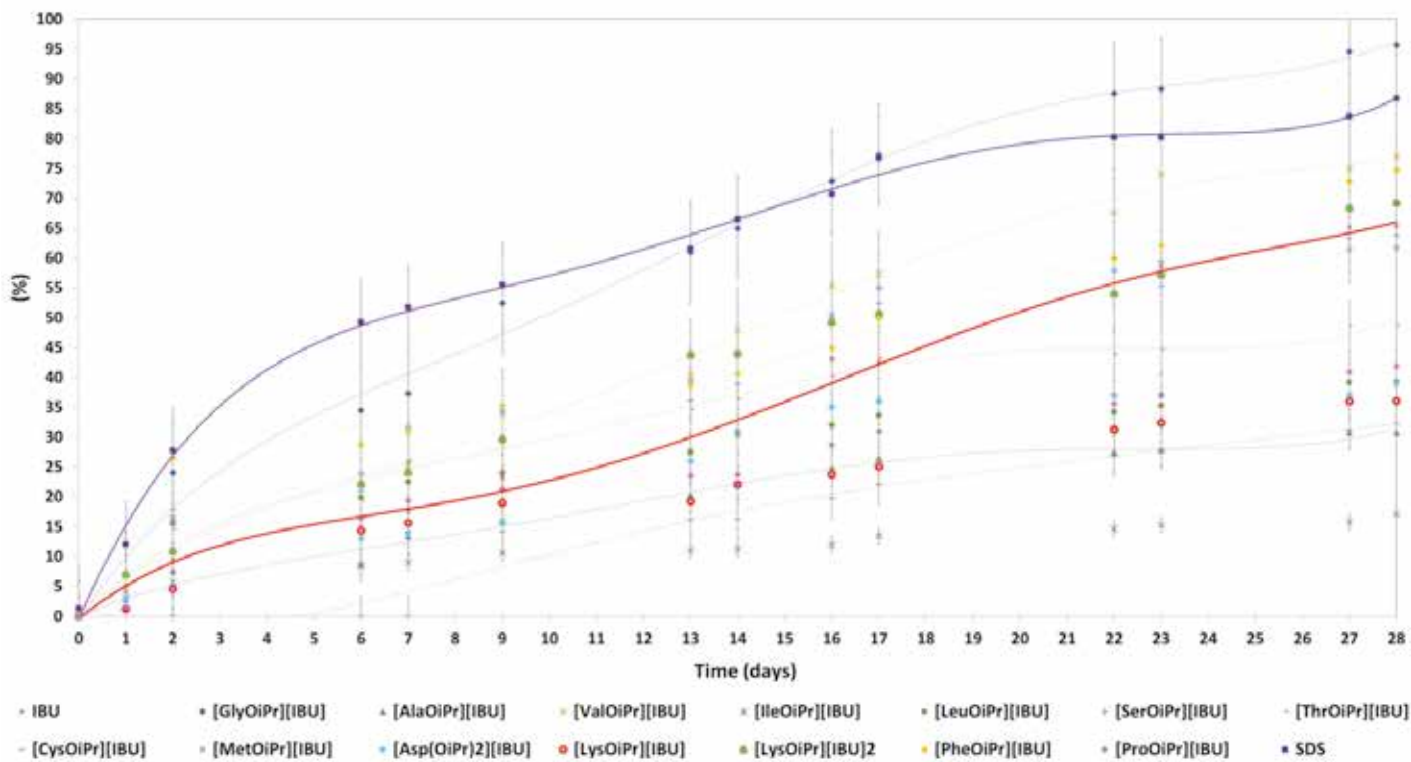

Figure 4. Biodegradation curves for the ibuprofen IBU (red line), and ibuprofen salts: [GlyOiPr][IBU], [AlaOiPr][IBU], [ValOiPr][IBU], [IleOiPr][IBU], [LeuOiPr][IBU], [SerOiPr][IBU], [ThrOiPr][IBU], [CysOiPr][IBU], [MetOiPr][IBU], [Asp(OiPr)₂][IBU], [LysOiPr][IBU], [LysOiPr][IBU]₂, [PheOiPr][IBU], [ProOiPr][IBU], and sodium dodecyl sulfate SDS (as reference compound – purple line).

compound - sodium dodecyl sulfate (87%±9) were characterised readily by biodegradability. In the case of eight compounds [AlaOiPr][IBU] (31%±3), [IleOiPr][IBU] (17%±4), [LeuOiPr][IBU] (39%±4), [ThrOiPr][IBU] (49%±3), [CysOiPr][IBU] (32%±2), [Asp(OiPr)₂][IBU] (39%±4), [LysOiPr][IBU] (36%±2) and [ProOiPr][IBU] (42%±5) poorly biodegradation susceptibility was observed, after 28 days of the experiment (Figure 4).

Table 1. The half-life of ibuprofen and its derivatives by bacterial cultures

The half-life of the analysed compound			
IBU	[GlyOiPr][IBU]	[AlaOiPr][IBU]	[ValOiPr][IBU]
(h/days)			
492/21	206/9	1093/46	347/15
[IleOiPr][IBU]	[LeuOiPr][IBU]	[SerOiPr][IBU]	[ThrOiPr][IBU]
(h/days)			
1959/82	856/36	389/16	689/29
[CysOiPr][IBU]	[MetOiPr][IBU]	[Asp(OiPr) ₂][IBU]	[LysOiPr][IBU]
(h/days)			
1043/44	381/16	862/36	932/39
[LysOiPr][IBU] ₂	[PheOiPr][IBU]	[ProOiPr][IBU]	SDS
(h/days)			
403/17	409/17	804/34	162/7

Table 2. Biodegradation of IBU, amino acid of ibuprofen derivatives and SDS by bacterial cultures.

Compound	Phase of degradation (%/h)		
	Lag phase	Degradation phase	Plateau phase
IBU	0-7/0-33	7-59/33-556	59-65/556-672
[GlyOiPr][IBU]	0-10/0-24	10-86/24-507	86-96/507-672
[AlaOiPr][IBU]	0-3/0-26	3-28/26-500	28-31/500-672
[ValOiPr][IBU]	0-8/0-34	8-69/34-517	69-77/517-672
[IleOiPr][IBU]	0-2/0-12	2-15/12-594	15-17/594-672
[LeuOiPr][IBU]	0-4/0-10	4-35/10-461	35-39/461-672
[SerOiPr][IBU]	0-6/0-21	6-58/21-604	58-64/604-672
[ThrOiPr][IBU]	0-5/0-17	5-44/17-465	44-49/465-672
[CysOiPr][IBU]	0-3/0-13	3-29/13-391	29-32/391-672
[MetOiPr][IBU]	0-6/0-19	6-56/19-451	56-62/451-672
[Asp(OiPr) ₂][IBU]	0-4/0-86	4-35/86-395	35-39/395-672
[LysOiPr][IBU]	0-4/0-37	4-32/37-349	32-37/349-672
[LysOiPr][IBU] ₂	0-7/0-29	7-62/29-626	62-69/626-672
[PheOiPr][IBU]	0-8/0-16	8-68/16-619	68-75/619-672
[ProOiPr][IBU]	0-4/0-17	4-38/17-587	38-42/587-672
SDS	0-9/0-15	9-78/15-537	78-87/537-672
SDS - sodium dodecyl sulfate (reference compound).			

The half-life of ibuprofen and its derivatives by bacterial cultures is shown in Table 1.

The half-life of ibuprofen was 21 days (Table 1). Furthermore, SDS and six modified compounds [GlyOiPr][IBU], [ValOiPr][IBU], [SerOiPr][IBU], [MetOiPr][IBU], [LysOiPr][IBU]₂, [PheOiPr][IBU] were characterised by a shorter half-life than ibuprofen: 7, 9, 15, 16 (both for Ser and Met derivatives), and 17 (both for Lys and Phe derivatives) days, respectively. The rest eight ibuprofen derivatives [ThrOiPr][IBU] (the half-life 29 days), [ProOiPr][IBU] (the half-life 34 days), [LeuOiPr][IBU] and [Asp(OiPr)₂][IBU] (the half-life 36 days), [LysOiPr][IBU] (the half-life 39 days), [CysOiPr][IBU] (the half-life 44 days), [AlaOiPr][IBU] (the half-life 46 days), and [IleOiPr][IBU] (the half-life 82 days) were characterised by a longer half-life, than the original ibuprofen - Table 1.

Table 2 presents the degradation phase of ibuprofen and its derivatives and SDS.

The ibuprofen reached 10% degradation after 33 hours, while ibuprofen derivatives [GlyOiPr][IBU], [AlaOiPr][IBU], [IleOiPr][IBU], [SerOiPr][IBU], [ThrOiPr][IBU], [CysOiPr][IBU], [MetOiPr][IBU], [LysOiPr][IBU]₂, [PheOiPr][IBU], [ProOiPr][IBU], and sodium dodecyl sulfate in less than 33 hours. Due to adaptations of the lag phase microorganisms, the compounds [ValOiPr][IBU], [Asp(OiPr)₂][IBU] and [LysOiPr][IBU] reach 10% degradation not until 34, 86 and 37 hours later. The degradation phase of IBU is 523 hours. In contrast, for 9 ibuprofen derivatives [GlyOiPr][IBU] (degradation time 483 h), [ValOiPr][IBU] (degradation time 483 h), [AlaOiPr][IBU] (degradation time 474 h), [LeuOiPr][IBU] (degradation time 451 h), [ThrOiPr][IBU] (degradation time 448 h), [MetOiPr][IBU] (degradation time 432 h), [CysOiPr][IBU] (degradation time 378 h), [LysOiPr][IBU] (degradation time 312 h), and [Asp(OiPr)₂][IBU] (degradation time 309 h) the degradation phase is shorter and ranges from 309 h to 483 h. For 5 ibuprofen and sodium dodecyl sulfate derivatives, the degradation phase is over 523 h: [IleOiPr][IBU] (degradation time 582 h), [SerOiPr][IBU] (degradation time 583 h), [LysOiPr][IBU]₂ (degradation time 597 h), [PheOiPr][IBU] (degradation time 603 h), [ProOiPr][IBU] (degradation time 570 h) - Table 2.

It has been shown that the structural modification of ibuprofen, specifically the introduction of different amino acids and alkyl esters, has a significant impact on the biodegradation of the drug. Here's how the structural modifications affect biodegradation:

a) Easily Biodegradable Compounds: [GlyOiPr][IBU], [ValOiPr][IBU], [SerOiPr][IBU], [MetOiPr][IBU], [LysOiPr][IBU]₂, and [PheOiPr][IBU] all showed high levels of biodegradation (ranging from 64% to 96%) after 28 days. This suggests that these modified compounds are readily biodegradable. The presence of specific amino acids and alkyl esters in these compounds likely enhances their susceptibility to microbial degradation. The structural modifications may make them more appealing to the biodegrading microorganisms, leading to higher degradation rates.

b) Poorly Biodegradable Compounds: [AlaOiPr][IBU], [IleOiPr][IBU], [LeuOiPr][IBU], [ThrOiPr][IBU], [CysOiPr][IBU], [Asp(OiPr)₂][IBU], [LysOiPr][IBU], and [ProOiPr][IBU] exhibited lower levels of biodegradation (ranging from 17% to 49%) after 28 days. These compounds, despite being structurally modified, showed a reduced susceptibility to biodegradation.

The specific modifications or combinations of amino acids and alkyl esters in these compounds may make them less accessible or less favourable to biodegrading microorganisms.

In summary, the structural modifications of ibuprofen, such as the incorporation of different amino acids and alkyl esters, have a direct impact on the biodegradability of the drug. Some modifications enhance biodegradability, making the compounds more easily degraded by microorganisms, while others reduce biodegradability, making them persist longer in the environment. The specific chemical structures and properties of the modified compounds likely play a crucial role in determining their biodegradation rates. Based on the structures of amino acid anions, differences in the biodegradability of different [AAOiPr][IBU] could be explained. The use of amino acids with branched side chains, such as Val, Leu, and Ile, as anions increased resistance to degradation by microorganisms, resulting in biodegradability of 17–39%, as opposed to the 96% biodegradability observed with the unbranched side chain of [GlyOiPr][IBU]. Similar observations have been made with amino acid anions to date. According to Petkovic et al., ILs with branched-chain alkanooate anions are more resistant to fungal attack than their linear isomers (Petkovic et al. 2010). In addition, Hou et al. found a decrease in the aerobic biodegradation of branched amino acid derivatives of choline [Chol][AA] (Hou et al. 2013). In our investigation, [AlaOiPr][IBU] exhibited unexpectedly high resistance to degradation (31% biodegradability). The presence of a hydroxyl group in the chain was not observed to increase biodegradability, as observed by other authors (Ford et al. 2010). In accordance with Boethling's principles of thumb (Boethling, Sommer & DiFiore 2007), the presence of carboxylate groups or hydrolysable bonds, such as ester and amide, increases aerobic biodegradability. However, the results of this study do not support these assumptions. What is also interesting and quite rare, the amino acid derivative containing the structure of a single aromatic ring [PheOiPr][IBU] gave relative biodegradability results (75%).

Metabolites analysis

Based on literature data on ibuprofen metabolites and transformation proposals from the Molecular Profiler program, a list of potential metabolites and possible transformations during the biodegradation process of analysed compounds was selected, presented in Table 3.

The results of the content of selected individual metabolites in the tested derivatives are shown in Figure 5. Detailed data obtained from the UPLC-MS/MS analysis are presented in Table 4. There is a strong similarity between the metabolite profile of ibuprofen and its amino acid derivatives. For all analysed compounds, the oxidation process and the formation of a metabolite with a molar mass of 222.13. Processes such as desaturation and the formation of a metabolite with a molar mass of 204.11 were also confirmed. In addition, in all analyzed samples, with the exception of [LysOiPr][IBU]₂, the process of Demethylation and Hydrogenation and the formation of 3-isobutylphenol are observed. We compared the contents of 5 metabolites observed and confirmed in the case of biodegradation, most ibuprofen derivatives. It can be seen that the change of the amino acid substituent affects the content and type of metabolites formed.

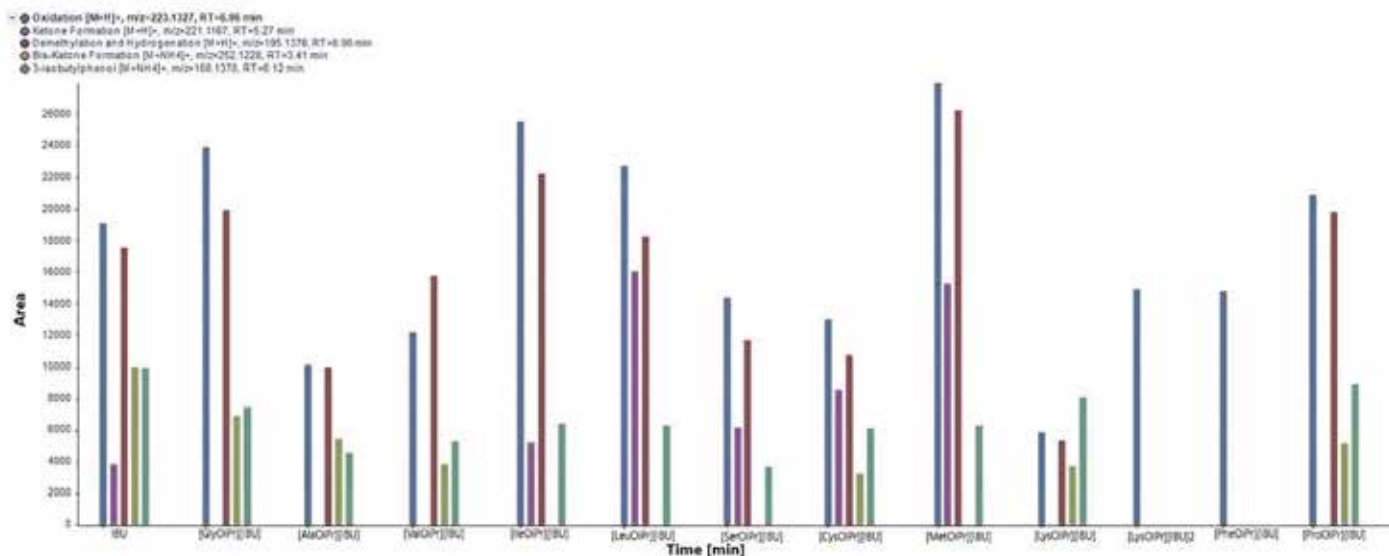

Figure 5. The content of selected metabolites after the biodegradation process.

Conclusions

The removal of ibuprofen by an activated sludge system is influenced by a number of physical and biological factors, including ibuprofen concentration in wastewater, the pretreatment system, environmental conditions, and the microbial community present in sludge (Chopra & Kumar 2020a). The inability of microorganisms to degrade ibuprofen could account for its presence in water (Rastogi, Tiwari & Ghangrekar 2021). In order to completely eliminate these compounds from wastewater, it is necessary to synthesize ibuprofen derivatives with a higher degradation profile in aquatic environments. This study evaluated the biodegradability of 16 organic compounds (including 14 novel ibuprofen salts) using activity sludge under aerobic conditions to ascertain their persistence in the environment. The OECD-recommended method for assessing the biodegradability of these compounds was proposed, in which aerobic biodegradability was evaluated by measuring the CO_2 emitted. The biodegradability degree was calculated. The results from three series of experiments were presented as the mean value with standard deviations. According to the biodegradability value, ibuprofen and its new derivatives were classified as readily or poorly biodegradable. Our research on the assessment of the biodegradation of ibuprofen and its derivatives by bacterial cultures showed that 8 of 14 compounds tested: IBU, [GlyOiPr][IBU], [ValOiPr][IBU], [SerOiPr][IBU], [MetOiPr][IBU], [LysOiPr][IBU]₂, [PheOiPr][IBU] and SDS constitute an attractive source of carbon and energy for the active sludge used. Within 28 days, these compounds were readily biodegradable. There were no simple relationships between the structure, properties of the obtained derivatives, and biodegradability.

The samples after biodegradation were subjected to *UPLC-MS/MS* analysis in order to analyze the metabolites, and it was shown that the metabolite profiles of ibuprofen and its derivatives are similar.

Funding: This work was financially supported by the National Centre for Research and Development (project no.

LIDER/53/0225/L-11/19/NCBR/2020).

Acknowledgments: For wastewater treatment plants - Oczyszczalnia ścieków "Pomorzany", Zakład Wodociągów i Kanalizacji Spółka z o.o. 71-682 Szczecin, ul. Golsza 10, for sewage sludge for research.

Conflicts of Interest: The authors declare no conflict of interest.

References

- Abbot, Vikrant, Diwakar Paliwal, Anuradha Sharma & Poonam Sharma (2022). A review on the physicochemical and biological applications of biosurfactants in biotechnology and pharmaceuticals. *Heliyon* 8(8). e10149. DOI:10.1016/j.heliyon.2022.e10149
- Adejokun, Deborah Adefunke & Kalliopi Dodou (2020). A Novel Method for the Evaluation of the Long-Term Stability of Cream Formulations Containing Natural Oils. *Cosmetics*. Multidisciplinary Digital Publishing Institute. 7(4). 86. DOI:10.3390/cosmetics7040086
- Alfonso-Muniozgueren, Pello, Efraim A. Serna-Galvis, Madeleine Bussemaker, Ricardo A. Torres-Palma & Judy Lee (2021). A review on pharmaceuticals removal from waters by single and combined biological, membrane filtration and ultrasound systems. *Ultrasonics Sonochemistry* 76. 105656. DOI:10.1016/j.ultrsonch.2021.105656
- Batucan, Niña Sarah P., Louis A. Tremblay, Grant L. Northcott & Christoph D. Matthaei (2022). Medicating the environment? A critical review on the risks of carbamazepine, diclofenac, and ibuprofen to aquatic organisms. *Environmental Advances* 7. 100164. DOI:10.1016/j.envadv.2021.100164
- Boethling, R. S., Elizabeth Sommer & David DiFiore (2007). Designing Small Molecules for Biodegradability. *Chemical Reviews* 107(6). 2207–2227. DOI:10.1021/cr050952t
- Chen, Weidong, Jie Wei, Zhiguo Su, Linwei Wu, Min Liu, Xiaoxuan Huang, Pengcheng Yao & Donghui Wen (2022). Deterministic mechanisms drive bacterial communities assembly in industrial

Table 3. A list of potential metabolites and possible transformations.

Name	Mass Shift	Description
Propionic acid	-132.0939	
2-hydroxymalonic acid	-86.1248	
2-hydroxysuccinic acid	-72.1092	
Isobutylbenzene	-72.0211	
2,3-dihydroxysuccinic acid	-56.1142	
2-phenylpropanoic acid	-56.0626	
3-isobutylphenol	-56.0262	
2,4-dimethylpentanedioic acid	-46.0571	
Decarboxylation	-43.9898	R-COOH to R-H
2-(x-hydroxyphenyl)propanoic acid	-40.0677	
Propyl Ketone to Acid	-40.0677	R-CH ₂ COC ₃ H ₇ to R-COOH
Loss of Hydroxymethylene	-30.0106	R-CH ₂ OH to R-H
Propyl Ether to Acid	-28.0677	R-CH ₂ OCH ₂ CH ₂ CH ₃ to R-COOH
Bis-Demethylation	-28.0313	CH ₃ -R-CH ₃ to R
Loss of CO	-27.9949	R-CO-R ¹ to R-R ¹
Ethyl Ketone to Acid	-26.0520	R-CH ₂ COCH ₂ CH ₃ to R-COOH
2-(x,y-dihydroxyphenyl)propanoic acid	-24.0728	
Loss of Water	-18.0106	R-H ₂ O to R
Demethylation and Desaturation	-16.0314	-CH ₂ - ₂ H
Ethyl Ether to Acid	-14.0520	R-CH ₂ OCH ₂ CH ₃ to R-COOH
Demethylation	-14.0157	R-CH ₃ to R-H
Ethyl to Alcohol	-12.0364	R-CH ₂ CH ₃ to R-OH
Demethylation and Hydrogenation	-12.0000	-CH ₂ + ₂ H
2-(x,y-dihydroxyphenyl)-2-hydroxypropanoic acid	-8.0779	
Desaturation	-2.0157	R-CH ₂ -CH ₂ -R ¹ to R-CHCH-R ¹
Demethylation and Methylene to Ketone	-0.0364	-CH ₂ -CH ₂ +CO
Parent	0	Parent (P)
Isopropyl to Acid	+1.9429	R-CH(CH ₃) ₂ to R-COOH
Demethylation and Oxidation	+1.9792	R-CH ₃ to R-OH
Hydrogenation	+2.0157	+2H
Deethylation and Carboxylic Acid Formation	+3.9585	R-CH ₂ CH ₃ to R-OOH
Di-Hydrogenation	+4.0313	+2H ₂
Ketone Formation	+13.9793	R-CH ₂ -R ¹ to R-CO-R ¹
Methylation	+14.0157	R-H to R-CH ₃
Ethyl to Carboxylic Acid	+15.9585	R-CH ₂ CH ₃ to R-COOH
Oxidation	+15.9949	+O
Demethylation and Di-Oxidation	+17.9742	R-CH ₂ CH ₃ to R-CH(OH) ₂
Internal Hydrolysis	+18.0106	R-CH=CH-R ¹ to R-CH ₂ -CHOH-R ¹
Bis-Ketone Formation	+27.9585	R-CH ₂ CH ₂ R ¹ to R-CO-CO-R ¹
Demethylation to Carboxylic Acid	+29.9742	RCH ₃ to RCOOH
Oxidation and Ketone Formation	+29.9742	+O-CH ₂ +CO
Carboxy ibuprofen	+29.9742	
Oxidation and Methylation	+30.0106	R-H to R-OCH ₃
Di-Oxidation	+31.9898	+2O
Tri-Oxidation and Demethylation	+33.9691	+3O-CH ₂
Oxidation and Internal Hydrolysis	+34.0055	+O+H ₂ O
Di-Oxidation and Ketone Formation	+45.9691	+2O-CH ₂ +CO
Tri-Oxidation	+47.9847	+3O
Tetra-Oxidation and Demethylation	+49.9640	+4O-CH ₂
Internal Hydrolysis and Di-Oxidation	+50.0004	+H ₂ O+ ₂ O
Glycine Conjugation	+57.0215	R-COOH to R-CONHCH ₂ COOH
2-(4-(2-formyl-1,1-dihydroxy-3-oxopropyl)phenyl)propanoic acid	+59.9484	
Tetra-Oxidation	+63.9796	+4O
2-(4-(2-formyl-1,1-dihydroxy-3-oxopropyl)phenyl)-3-oxopropanoic acid	+73.9276	
Sulfate Conjugation	+79.9568	R-OH to R-OSO ₃ H

Name	Mass Shift	Description
Phosphorylation	+79.9663	R-H to R-H ₂ PO ₃
2-(4-(2-formyl-1,1,2-trihydroxy-3-oxopropyl)phenyl)-3-oxopropanoic acid	+89.9225	
3-(4-(1-carboxy-1-hydroxyethyl)phenyl)-2,3,3-trihydroxy-2-methylpropanoic acid	+93.9538	
Oxidation and Sulfate Conjugation	+95.9517	R-H- to R-OSO ₃ H
3-hydroxy-2-(4-(1,1,2,3-tetrahydroxy-2-(hydroxymethyl)propyl)phenyl)propanoic acid	+95.9695	
Cysteine Conjugation	+103.0092	R-COOH to R-CONH-CHCH ₂ SH-COOH
Taurine Conjugation	+107.0041	R-COOH to R-CONH-CH ₂ CH ₂ SO ₃ H
2-((4-(1-carboxy-1-hydroxyethyl)phenyl)dihydroxymethyl) malonic acid	+107.9331	
Oxidation and Cysteine Conjugation	+119.0041	+O+C ₃ H ₇ NO ₂ S-H ₂ O
S-Cysteine Conjugation	+119.0041	RR ¹ -CH ₂ to RR ¹ -CH-SCH ₂ CHNH ₂ -COOH
Oxidation and Taurine Conjugation	+122.9990	+O+C ₂ H ₇ NO ₃ S-H ₂ O
Glutamine Conjugation	+128.0586	R-COOH to R-CONHCH((CH ₂) ₂ CONH ₂)COOH
3-methoxy-2-(4-(3-methoxy-2-(methoxycarbonyl)-3-oxopropyl)phenyl)-3-oxopropanoic acid	+131.9695	
Dimethyl 2-(dihydroxy(4-(1-methoxy-1-oxopropan-2-yl)phenyl)methyl) malonate	+133.9851	
Di-Oxidation and Cysteine Conjugation	+134.9990	+2O+C ₃ H ₇ NO ₂ S-H ₂ O
2-((4-(dicarboxymethyl)phenyl)dihydroxymethyl)-2-hydroxymalonic acid	+137.9073	
Di-Oxidation and Taurine Conjugation	+138.9939	+2O+C ₂ H ₇ NO ₃ S-H ₂ O
Oxidation and Glutamine Conjugation	+144.0535	+O+C ₅ H ₁₀ N ₂ O ₃ -H ₂ O
Bis-Sulfate Conjugation	+159.9136	+2(SO ₃)
Bis-Phosphorylation	+159.9327	+2(HPO ₃)
Demethylation and Glucuronide Conjugation	+162.0165	-CH ₃ + C ₆ H ₈ O ₆
Glucose Conjugation	+162.0528	R-OH to R-O-C ₆ H ₁₁ O ₅
2-(4-(1,1-dihydroxy-3-methoxy-2-methoxycarbonyl)-3-oxopropyl)phenyl)-3-methoxy-3-oxopropanoic acid	+163.9593	
Glucuronidation	+176.0321	R-H to R-C ₆ H ₉ O ₆
2-((4-(dicarboxy(hydroxy)methyl)-2,5-dihydroxyphenyl)dihydroxymethyl)-2-hydroxymalonic acid	+185.8920	
Oxidation and Glucuronide Conjugation	+192.0270	R-H to R-O-C ₆ H ₈ O ₆
Di-Oxidation and Glucuronide Conjugation	+208.0219	+2O+C ₆ H ₈ O ₆
Tri-Oxidation and Glucuronide Conjugation	+224.0168	+3O+C ₆ H ₈ O ₆
Sulfate and Glucuronide Conjugation	+255.9889	+SO ₃ +C ₆ H ₈ O ₆
Oxidation and Sulfate and Glucuronide Conjugation	+271.9838	+C ₆ H ₈ O ₆ +O+SO ₃
Glutathione Conjugation and Loss of H ₂ S	+273.0961	+C ₁₀ H ₁₇ N ₃ O ₆ S-H ₂ S
S-Glutathione Conjugation	+305.0682	+C ₁₀ H ₁₅ N ₃ O ₆ S
Glutathione Conjugation	+307.0838	+C ₁₀ H ₁₇ N ₃ O ₆ S
Glutathione Conjugation and Oxidation	+323.0787	+C ₁₀ H ₁₇ N ₃ O ₆ S+O
Bis-Glucuronide Conjugation	+352.0642	+2(C ₆ H ₈ O ₆)
Oxidation and Bis-Glucuronide Conjugation	+368.0591	O+2(C ₆ H ₈ O ₆)
Di-Oxidation and Bis-Glucuronidation	+384.0540	2O+2(C ₆ H ₈ O ₆)
Tri-Oxidation and Bis-Glucuronidation	+400.0489	3O+2(C ₆ H ₈ O ₆)

wastewater treatment system. *Environment International* 168. 107486. DOI:10.1016/j.envint.2022.107486

Chopra, Sunil & Dharmender Kumar (2020a). Ibuprofen as an emerging organic contaminant in environment, distribution and remediation. *Heliyon*. Elsevier Ltd. 6(6). e04087. DOI:10.1016/j.heliyon.2020.e04087

Chopra, Sunil & Dharmender Kumar (2020b). Ibuprofen as an emerging organic contaminant in environment, distribution and remediation. *Heliyon* 6(6). e04087. DOI:10.1016/j.heliyon.2020.e04087

Chopra, Sunil & Dharmender Kumar (2022). Characteristics and growth kinetics of biomass of *Citrobacter freundii* strains

PYI-2 and *Citrobacter portucalensis* strain YPI-2 during the biodegradation of Ibuprofen. *International Microbiology* 25(3). 615–628. DOI:10.1007/s10123-022-00248-7

Collivignarelli, Maria Cristina, Francesca Maria Caccamo, Stefano Bellazzi, Alessandro Abbà & Giorgio Bertanza (2023). Assessment of the Impact of a New Industrial Discharge on an Urban Wastewater Treatment Plant: Proposal for an Experimental Protocol. *Environments* 10(7). 108. DOI:10.3390/environments10070108

Conco, Thobela (2016). Determination of the relationship between epiphytes and selected filamentous bacteria in activated sludge. (= PhD Thesis).

- Conco, Thobela, Sheena Kumari, Thor Stenström & Faizal Bux (2018). Epibiont growth on filamentous bacteria found in activated sludge: a morphological approach. *Archives of Microbiology* 200(3). 493–503. DOI:10.1007/s00203-017-1461-3
- Ford, Leigh, Jitendra R. Harjani, Farzad Atefi, M. Teresa Garcia, Robert D. Singer & Peter J. Scammells (2010). Further studies on the biodegradation of ionic liquids. *Green Chemistry* 12(10). 1783. DOI:10.1039/c0gc00082e
- Hamiruddin, Nur Ain & Nik Azimatolakma Awang (2021). The Relationship Between the Biokinetic Parameters of an Aerobic Granular Sludge System and the Applied Operating Conditions. *Civil and Environmental Engineering Reports*. University of Zielona Góra. 31(1). 161–171. DOI:10.2478/ceer-2021-0011
- Hashem, Amr H., Mohamed S. Attia, Eslam K. Kandil, Mahmoud M. Fawzi, Ahmed S. Abdelrahman, Mohamed S. Khader, Mohamed A. Khodaira, Abdallah E. Emam, Mohamed A. Goma & Amer M. Abdelaziz (2023). Bioactive compounds and biomedical applications of endophytic fungi: a recent review. *Microbial Cell Factories* 22(1). 107. DOI:10.1186/s12934-023-02118-x
- Hawash, Hamada B., Abeer A. Moneer, Ahmed A. Galhoum, Ahmed M. Elgarahy, Walied A.A. Mohamed, Mahmoud Samy, Hesham R. El-Seedi, Mohamed S. Gaballah, Mahmoud F. Mubarak & Nour F. Attia (2023). Occurrence and spatial distribution of pharmaceuticals and personal care products (PPCPs) in the aquatic environment, their characteristics, and adopted legislations. *Journal of Water Process Engineering* 52. 103490. DOI:10.1016/j.jwpe.2023.103490
- Hou, Xue-Dan, Qiu-Ping Liu, Thomas J. Smith, Ning Li & Min-Hua Zong (2013). Evaluation of Toxicity and Biodegradability of Cholinium Amino Acids Ionic Liquids. (Ed.) Vipul Bansal *PLoS ONE* 8(3). e59145. DOI:10.1371/journal.pone.0059145
- Jan-Roblero, Janet & Juan A. Cruz-Maya (2023). Ibuprofen: Toxicology and Biodegradation of an Emerging Contaminant. *Molecules* 28(5). 2097. DOI:10.3390/molecules28052097
- Janus, Ewa, Paula Ossowicz, Joanna Klebeko, Anna Nowak, Wiktoria Duchnik, Łukasz Kucharski & Adam Klimowicz (2020). Enhancement of ibuprofen solubility and skin permeation by conjugation with L-valine alkyl esters. *RSC Advances*. The Royal Society of Chemistry. 10(13). 7570–7584. DOI:10.1039/D0RA00100G
- Kamal, M., W.A. Negm, A.M. Abdelkader, A.A. Alshehri, G. El-Saber Batiha & H. Osama (2023). Most common over-the-counter medications and effects on patients. *European Review for Medical and Pharmacological Sciences* 27(4). 1654–1666. DOI:10.26355/eurrev_202302_31409
- Kayani, Mahmood A., James M. Parry, Susan Vickery & Peter F. Dodds (2009). In vitro genotoxic assessment of xenobiotic diacylglycerols in an in vitro micronucleus assay. *Environmental and Molecular Mutagenesis* 50(4). 277–284. DOI:10.1002/em.20445
- Khasawneh, Omar Fawzi Suleiman, Puganeshwary Palaniandy & Hamidi Abdul Aziz (2023). Fate of common pharmaceuticals in the environment. *The Treatment of Pharmaceutical Wastewater*, 69–148. Elsevier. DOI:10.1016/B978-0-323-99160-5.00011-4
- Klebeko, Joanna, Oliver Krüger, Mateusz Dubicki, Paula Ossowicz-Rupniewska & Ewa Janus (2022). Isopropyl Amino Acid Esters Ionic Liquids as Vehicles for Non-Steroidal Anti-Inflammatory Drugs in Potential Topical Drug Delivery Systems with Antimicrobial Activity. *International Journal of Molecular Sciences* 23(22). 13863. DOI:10.3390/ijms232213863
- Klebeko, Joanna, Paula Ossowicz-Rupniewska, Anna Nowak, Edyta Kucharska, Łukasz Kucharski, Wiktoria Duchnik, Łukasz Struk, Adam Klimowicz & Ewa Janus (2023). Cations of amino acid alkyl esters conjugated with an anion from the group of NSAIDs – As tunable pharmaceutical active ionic liquids. *Journal of Molecular Liquids* 384. 122200. DOI:10.1016/j.molliq.2023.122200
- Kumar, Dharmender & Sunil Chopra (2022). Characterisation and kinetic study of Ibuprofen Biodegradation by native bacterial Citrobacter strains PPYI-2 and YPI-2. Preprint In Review. DOI:10.21203/rs.3.rs-1306737/v1
- Lohmann, Rainer & Jordi Dachs (2010). Deposition of Dissolved and Particulate-Bound Chemicals from the Surface Ocean. *Handbook of Chemical Mass Transport in the Environment*, 18. 1st Edition. CRC Press
- Makuch, Edyta, Paula Ossowicz-Rupniewska, Joanna Klebeko & Ewa Janus (2021). Biodegradation of L-Valine Alkyl Ester Ibuprofenates by Bacterial Cultures. *Materials* 14(12). 3180. DOI:10.3390/ma14123180
- Marchlewicz, Ariel, Urszula Guzik, Katarzyna Hupert-Kocurek, Agnieszka Nowak, Sylwia Wilczyńska & Danuta Wojcieszynska (2017). Toxicity and biodegradation of ibuprofen by *Bacillus thuringiensis* B1(2015b). *Environmental Science and Pollution Research* 24(8). 7572–7584. DOI:10.1007/s11356-017-8372-3
- Nowak, Anna, Martyna Zagórska-Dziok, Magdalena Perużyńska, Krystyna Cybulska, Edyta Kucharska, Paula Ossowicz-Rupniewska, Katarzyna Piotrowska, et al. (2022). Assessment of the Anti-Inflammatory, Antibacterial and Anti-Aging Properties and Possible Use on the Skin of Hydrogels Containing *Epilobium angustifolium* L. Extracts. *Frontiers in Pharmacology* 13. 896706. DOI:10.3389/fphar.2022.896706
- Ossowicz, Paula, Joanna Klebeko, Ewa Janus, Anna Nowak, Wiktoria Duchnik, Łukasz Kucharski & Adam Klimowicz (2020). The effect of alcohols as vehicles on the percutaneous absorption and skin retention of ibuprofen modified with L -valine alkyl esters. *RSC Advances* 10(68). 41727–41740. DOI:10.1039/D0RA06567F
- Ossowicz-Rupniewska, Paula, Joanna Klebeko, Ewelina Świątek, Karolina Bilaska, Anna Nowak, Wiktoria Duchnik, Łukasz Kucharski, et al. (2022a). Influence of the Type of Amino Acid on the Permeability and Properties of Ibuprofenates of Isopropyl Amino Acid Esters. *International Journal of Molecular Sciences* 23(8). 4158. DOI:10.3390/ijms23084158
- Ossowicz-Rupniewska, Paula, Joanna Klebeko, Ewelina Świątek, Joanna Szachnowska, Ewa Janus, Miroslav Rangelov, Nadezhda Todorova, Stefka G. Taneva, Elena Krachmarova & Maya Guncheva (2022b). Binding behavior of ibuprofen-based ionic liquids with bovine serum albumin: Thermodynamic and molecular modeling studies. *Journal of Molecular Liquids* 360. 119367. DOI:10.1016/j.molliq.2022.119367
- Ossowicz-Rupniewska, Paula, Rafał Rakoczy, Anna Nowak, Maciej Konopacki, Joanna Klebeko, Ewelina Świątek, Ewa Janus, et al. (2021). Transdermal Delivery Systems for Ibuprofen and Ibuprofen Modified with Amino Acids Alkyl Esters Based on Bacterial Cellulose. *International Journal of Molecular Sciences* 22(12). 6252. DOI:10.3390/ijms22126252
- Ossowicz-Rupniewska, Paula, Kaja Szczepkowska, Paulina Bednarczyk, Małgorzata Nowak, Anna Nowak, Wiktoria Duchnik, Łukasz Kucharski, Łukasz Struk, Adam Klimowicz & Zbigniew Czech (2022c). New amino acid propyl ester

- ibuprofenates from synthesis to use in drug delivery systems. *RSC Advances* 12(55). 35779–35792. DOI:10.1039/D2RA05804A
- Petkovic, Marija, Jamie L. Ferguson, H. Q. Nimal Gunaratne, Rui Ferreira, Maria C. Leitão, Kenneth R. Seddon, Luís Paulo N. Rebelo & Cristina Silva Pereira (2010). Novel biocompatible cholinium-based ionic liquids—toxicity and biodegradability. *Green Chemistry* 12(4). 643. DOI:10.1039/b922247b
- Preglo, Aj Rosemay, Jessel Namata, Janeth Caculba, Glyn Sanchez, Cherry Joyno, Efren Pagalan & Renato O. Arazo (2023). Paracetamol Removal from Aqueous Solution Through Activated Carbon from Mango Seeds. *Chemistry Africa* 6(2). 699–710. DOI:10.1007/s42250-023-00597-4
- Rastogi, Aishwarya, Manoj Kumar Tiwari & Makarand M. Ghangrekar (2021). A review on environmental occurrence, toxicity and microbial degradation of Non-Steroidal Anti-Inflammatory Drugs (NSAIDs). *Journal of Environmental Management* 300. 113694. DOI:10.1016/j.jenvman.2021.113694
- Revaprasadu, Neerish & Malik Dilshad Khan (Hrsg.) (2021). *Nanoscience: Volume 7* (Nanoscience). Bd. 7. Cambridge: Royal Society of Chemistry. DOI:10.1039/9781839163791
- Riva, Francesco, Ettore Zuccato, Enrico Davoli, Elena Fattore & Sara Castiglioni (2019). Risk assessment of a mixture of emerging contaminants in surface water in a highly urbanised area in Italy. *Journal of Hazardous Materials* 361. 103–110. DOI:10.1016/j.jhazmat.2018.07.099
- Salesa, Beatriz, Encarnación Sancho, María Dolores Ferrando-Rodrigo & Javier Torres-Gavilá (2022). The prochloraz chronic exposure to *Daphnia magna* derived in biochemical alterations of F0 generation daphnids and malformed F1 progeny. *Chemosphere* 307. 135848. DOI:10.1016/j.chemosphere.2022.135848
- Wagner, Michael, Rudolf Amann, Peter Kämpfer, Bernhard Assmus, Anton Hartmann, Peter Hutzler, Nina Springer & Karl-Heinz Schleifer (1994). Identification and in situ Detection of Gram-negative Filamentous Bacteria in Activated Sludge. *Systematic and Applied Microbiology* 17(3). 405–417. DOI:10.1016/S0723-2020(11)80058-5
- Zhang, Meng, Junqin Yao, Xiyuan Wang, Ying Hong & Yinguang Chen (2019). The microbial community in filamentous bulking sludge with the ultra-low sludge loading and long sludge retention time in oxidation ditch. *Scientific Reports*. Nature Publishing Group. 9(1). 13693. DOI:10.1038/s41598-019-50086-3
- Żur, Joanna, Artur Piński, Ariel Marchlewicz, Katarzyna Hupert-Kocurek, Danuta Wojcieszynska & Urszula Guzik (2018). Organic micropollutants paracetamol and ibuprofen—toxicity, biodegradation, and genetic background of their utilisation by bacteria. *Environmental Science and Pollution Research* 25(22). 21498–21524. DOI:10.1007/s11356-018-2517-x

	Neutral Mass	Average Mass	m/z	R.T. (min)	IBU	[GlyOiPr][IBU]	[AlaOiPr][IBU]	[ValOiPr][IBU]	[IleOiPr][IBU]	[LeuOiPr][IBU]	[SerOiPr][IBU]	[CysOiPr][IBU]	[MetOiPr][IBU]	[LysOiPr][IBU]	[LysOiPr][IBU] ₂	[PheOiPr][IBU]	[ProOiPr][IBU]
Ethyl Ketone to Acid [M+H] ⁺	180.08	180.0778	181.0851	6.37													
Ethyl to Carboxylic Acid [M+H] ⁺	222.09	222.0884	223.0957	5.65	1.78E+04											3.04E+03	
Gain of 104.1311 [M+H] ⁺	310.26	310.2618	311.2691	7.4												1.78E+05	
Gain of 104.1316 [M+H] ⁺	310.26	310.2619	311.2695	7.34	2.14E+05	1.62E+05	1.62E+05	7.10E+04	1.90E+05	1.79E+05	7.22E+04	1.71E+05	1.68E+05	2.31E+05	1.93E+05	1.85E+05	
Gain of 105.1125 [M+H] ⁺	311.24	311.2431	312.2504	6.15				4.83E+04			4.35E+04						
Gain of 105.1126 [M+H] ⁺	311.24	311.2433	312.2506	6.2											2.69E+05		
Gain of 107.0939 [M+H] ⁺	313.22	313.2246	314.2319	10.38					8.93E+04								
Gain of 107.0940 [M+H] ⁺	313.22	313.2246	314.2319	10.9					4.33E+04								
Gain of 109.0856 [M+H] ⁺	315.22	315.2163	316.2236	10.04							2.28E+04						
Gain of 109.0860 [M+H] ⁺	315.22	315.2167	316.224	10.17							5.92E+04						
Gain of 109.6274 [M+2H] ²⁺	1302.76	1302.758	652.3863	13.73			1.35E+06										
Gain of 11.0726 [M+H] ⁺	217.2	217.2032	218.2105	4.96													
Gain of 11.0728 [M+H] ⁺	217.2	217.2033	218.2107	4.85													
Gain of 11.0732 [M+H] ⁺	217.2	217.204	218.2112	4.61					8.91E+03	1.30E+04							
Gain of 11.0732 [M+H] ⁺	217.2	217.2037	218.2111	4.78	9.15E+03	8.32E+03	1.02E+04	9.43E+05			6.98E+05		1.06E+06	9.93E+05		1.09E+06	
Gain of 11.0734 [M+H] ⁺	217.2	217.204	218.2114	4.66	1.10E+06	9.02E+05	9.31E+05	8.96E+03			9.25E+03	1.32E+04	1.22E+04		3.57E+06	1.10E+06	1.30E+04
Gain of 11.1017 [M+H] ⁺	317.23	317.2324	318.2397	9.59													
Gain of 11.1620 [M+H] ⁺	317.29	317.2928	318.3	7.23	1.69E+06	1.94E+06	1.68E+06	1.87E+06	1.50E+06	1.55E+06	1.93E+06	1.88E+06	2.01E+06		6.31E+06	1.96E+06	1.88E+06
Gain of 11.1620 [M+H] ⁺	317.29	317.2927	318.2999	8.28													
Gain of 11.1172 [M+H] ⁺	319.25	319.2479	320.2552	9.89							2.94E+04						
Gain of 11.1175 [M+H] ⁺	319.25	319.2482	320.2554	11.26							4.36E+04						
Gain of 11.1677 [M+H] ⁺	319.3	319.2985	320.3057	7.24			4.60E+04				4.69E+04						
Gain of 12.0364 [M+H] ⁺	218.17	218.1671	219.1744	0.65													
Gain of 120.0210 [M+H] ⁺	326.15	326.1517	327.159	10.72	3.40E+05												
Gain of 120.0211 [M+H] ⁺	326.15	326.1517	327.159	10.31	3.53E+05												
Gain of 121.0953 [M+H] ⁺	327.23	327.226	328.2333	3.34													
Gain of 123.9794 [M+H] ⁺	330.11	330.1101	331.1173	6.64	2.07E+04												
Gain of 123.9794 [M+H] ⁺	330.11	330.1101	331.1174	7.74	1.48E+05												
Gain of 123.9796 [M+H] ⁺	330.11	330.1103	331.1175	7.28	2.58E+04												
Gain of 125.1041 [M+H] ⁺	331.23	331.2348	332.2421	6.4					5.53E+03								
Gain of 125.1048 [M+H] ⁺	331.24	331.2355	332.2428	6.22					1.93E+05								
Gain of 125.1050 [M+H] ⁺	331.24	331.2357	332.243	6.11					6.61E+04								
Gain of 125.1051 [M+H] ⁺	331.24	331.2358	332.2431	6.29					4.96E+05								
Gain of 125.6800 [M+2H] ²⁺	1464.81	1464.811	733.4126	13.76				1.66E+05									
Gain of 125.6807 [M+2H] ²⁺	1464.81	1464.811	733.413	13.41			4.13E+05										
Gain of 125.6808 [M+2H] ²⁺	1464.81	1464.812	733.413	7.85						9.59E+04							
Gain of 125.6808 [M+2H] ²⁺	1464.81	1464.811	733.413	13.58					1.40E+05	2.23E+05							
Gain of 125.6809 [M+2H] ²⁺	1464.81	1464.812	733.4131	14.66					7.96E+03								
Gain of 125.6811 [M+2H] ²⁺	1464.81	1464.812	733.4131	14.84						1.06E+04							
Gain of 125.6816 [M+2H] ²⁺	1464.81	1464.812	733.4134	14.92													
Gain of 126.1128 [M+H] ⁺	332.24	332.2435	333.2508	7.37				6.80E+03									
Gain of 127.1567 [M+H] ⁺	333.29	333.2876	334.2947	6.25					7.70E+04				5.47E+04				5.87E+04

Table 4. Profiling results

Table 4. Profiling results

	Neutral Mass	Average Mass	m/z	R.T. (min)	IBU	[GlyOiPr][IBU]	[AlaOiPr][IBU]	[ValOiPr][IBU]	[IleOiPr][IBU]	[LeuOiPr][IBU]	[SerOiPr][IBU]	[CysOiPr][IBU]	[MetOiPr][IBU]	[LysOiPr][IBU]	[LysOiPr][IBU] ₂	[PheOiPr][IBU]	[ProOiPr][IBU]	
Gain of 185.9765 [M+H] ⁺	392.11	392.1072	393.1145	8.84								1.28E+05						
Gain of 186.0718 [M+H] ⁺	392.2	392.2025	393.2098	4.1									2.63E+05		2.60E+05		2.40E+05	
Gain of 186.0720 [M+H] ⁺	392.2	392.2027	393.21	3.88	4.27E+05	2.59E+05	2.54E+05			2.64E+05				3.33E+05				
Gain of 195.0957 [M+H] ⁺	401.23	401.2264	402.2337	3.94										1.15E+05				
Gain of 199.2140 [M+H] ⁺	405.34	405.3447	406.3519	7.35			6.20E+04				8.95E+04							
Gain of 208.0725 [M+H] ⁺	414.2	414.2037	415.2104	8.81	1.20E+04						1.42E+04							
Gain of 208.0731 [M+H] ⁺	414.2	414.2039	415.2111	9.49	2.67E+04	2.19E+04	1.45E+04		1.85E+04		2.29E+04		1.89E+04		3.24E+04	2.61E+04		
Gain of 208.0734 [M+H] ⁺	414.2	414.2042	415.2113	9.25	4.36E+05	3.18E+05	3.83E+05	2.42E+05	3.08E+05	2.10E+05	3.07E+05	2.63E+05	3.25E+05	3.70E+05	4.74E+05	3.43E+05	3.46E+05	
Gain of 208.0738 [M+H] ⁺	414.2	414.204	415.2117	9.68	2.91E+04	5.70E+04	1.32E+04				4.04E+04	3.52E+04			3.44E+04	4.15E+04	4.15E+04	
Gain of 208.0738 [M+H] ⁺	414.2	414.2045	415.2118	8.82		24600												
Gain of 208.1160 [M+H] ⁺	414.25	414.2467	415.254	4.32												2.50E+05		
Gain of 208.1162 [M+H] ⁺	414.25	414.2468	415.2542	4.08	4.67E+05	2.75E+05	2.61E+05	5.08E+04	2.58E+05	2.94E+05	1.57E+05	1.57E+05	2.67E+05	3.43E+05			2.47E+05	
Gain of 209.0747 [M+H] ⁺	415.21	415.2054	416.2127	4.25											3.37E+05			
Gain of 209.0752 [M+H] ⁺	415.21	415.2059	416.2132	4.02										1.37E+05				
Gain of 209.1475 [M+H] ⁺	415.28	415.2782	416.2854	4.1												2.97E+05		
Gain of 209.1478 [M+H] ⁺	415.28	415.2785	416.2858	3.88	4.35E+05	2.91E+05	3.01E+05		2.78E+05	3.02E+05	1.89E+05	1.89E+05	3.05E+05	3.57E+05			2.76E+05	
Gain of 21.0935 [M+H] ⁺	227.22	227.2242	228.2315	6.02														
Gain of 217.2158 [M+H] ⁺	423.35	423.3459	424.3538	7.17	2.89E+05	2.35E+05	2.43E+05	1.54E+05	2.72E+05	2.97E+05	1.46E+05	2.61E+05	2.60E+05	3.09E+05	2.25E+05	2.53E+05	2.66E+05	
Gain of 225.1001 [M+H] ⁺	431.23	431.2305	432.238	9.26			1.17E+05	7.54E+04			7.55E+04			9.84E+04				
Gain of 225.1427 [M+H] ⁺	431.27	431.2733	432.2806	4.32											4.48E+05	1.23E+06		
Gain of 225.1429 [M+H] ⁺	431.27	431.2735	432.2809	4.08	2.24E+06	1.39E+06	1.41E+06	2.97E+05	1.34E+06	1.44E+06	7.87E+05	1.32E+06	1.32E+06	1.62E+06	2.58E+05	1.64E+05	1.21E+06	
Gain of 230.0549 [M+H] ⁺	436.19	436.1859	437.1929	8.83		17800							1.89E+05			2.10E+04	2.09E+05	
Gain of 230.0551 [M+H] ⁺	436.19	436.1859	437.1932	9.49	3.52E+04	3.22E+04	2.03E+04	1.46E+04	2.58E+04		3.60E+04	2.80E+04	2.74E+04		5.19E+04	3.89E+04	3.57E+04	
Gain of 230.0553 [M+H] ⁺	436.19	436.1861	437.1933	9.25	3.85E+05	2.81E+05	3.27E+05	2.10E+05	2.73E+05	1.91E+05	3.22E+05	2.75E+05	3.02E+05	3.36E+05	4.57E+05	3.43E+05	3.21E+05	
Gain of 230.0557 [M+H] ⁺	436.19	436.1859	437.1936	9.69	3.64E+04	7.45E+04			2.54E+04		5.65E+04	5.03E+04			5.15E+04	5.70E+04	5.95E+04	
Gain of 230.0561 [M+H] ⁺	436.19	436.1862	437.1941	9.82		28100										2.32E+04		
Gain of 230.0981 [M+H] ⁺	436.23	436.2288	437.236	4.32												2.51E+05	2.58E+05	
Gain of 230.0982 [M+H] ⁺	436.23	436.2287	437.2362	4.08	4.69E+05	2.77E+05	2.48E+05	3.74E+04	2.57E+05	2.92E+05	1.61E+05	2.72E+05	3.62E+05					
Gain of 239.1421 [M+H] ⁺	445.25	445.2528	446.26	4.15										1.55E+05				
Gain of 239.1979 [M+H] ⁺	445.33	445.328	446.3359	7.17	2.06E+05	1.65E+05	1.48E+05	8.09E+04	1.60E+05	1.72E+05	1.05E+05	1.78E+05	1.69E+05	2.10E+05		1.72E+05	1.86E+05	
Gain of 246.0290 [M+H] ⁺	452.16	452.1597	453.167	9.69							2.36E+04							
Gain of 246.0300 [M+H] ⁺	452.16	452.1601	453.1679	9.26			1.35E+05	8.79E+04			1.13E+05			1.44E+05				
Gain of 246.2049 [M+H] ⁺	452.34	452.3356	453.3429	4.97											8.97E+04			
Gain of 246.2053 [M+H] ⁺	452.34	452.3362	453.3432	5.29	3.55E+04	3.01E+04	3.23E+04				3.03E+04		2.98E+04		6.38E+04			
Gain of 246.2056 [M+H] ⁺	452.34	452.3365	453.3436	5.12		47600	4.94E+04			4.62E+04			5.98E+04	6.27E+04		6.54E+04		
Gain of 246.2057 [M+H] ⁺	452.34	452.3361	453.3437	4.85	6.68E+04				7.51E+04	8.65E+04					6.50E+05	8.36E+05	7.99E+04	
Gain of 246.2058 [M+H] ⁺	452.34	452.3365	453.3437	4.79										8.67E+04				
Gain of 246.2060 [M+H] ⁺	452.34	452.3367	453.3439	4.47						3.76E+05								
Gain of 246.2061 [M+H] ⁺	452.34	452.3364	453.3441	4.39	5.25E+05	3.38E+05	3.50E+05	1.65E+05	3.98E+05	1.42E+05	3.28E+05	3.80E+05	3.80E+05	5.76E+05		3.90E+05		
Gain of 252.1421 [M+H] ⁺	458.27	458.2728	459.2801	4.5													2.11E+05	
Gain of 252.1424 [M+H] ⁺	458.27	458.2732	459.2804	4.28	3.84E+05	2.23E+05	2.11E+05		2.15E+05			1.29E+05	2.17E+05	3.13E+05			1.94E+05	

	Neutral Mass	Average Mass	m/z	R.T. (min)	IBU	[GlyOiPr][IBU]	[AlaOiPr][IBU]	[ValOiPr][IBU]	[IleOiPr][IBU]	[LeuOiPr][IBU]	[SerOiPr][IBU]	[CysOiPr][IBU]	[MetOiPr][IBU]	[LysOiPr][IBU]	[LysOiPr][IBU] ₂	[PheOiPr][IBU]	[ProOiPr][IBU]	
Gain of 252.1427 [M+H] ⁺	458.27	458.2734	459.2806	4.35						2.31E+05								
Gain of 253.1011 [M+H] ⁺	459.23	459.2318	460.239	4.46										4.37E+05				
Gain of 253.1016 [M+H] ⁺	459.23	459.2323	460.2396	4.23										1.68E+05				
Gain of 253.1308 [M+H] ⁺	459.26	459.2614	460.2687	9.26						5.68E+04								
Gain of 253.1737 [M+H] ⁺	459.3	459.3044	460.3116	4.32											2.86E+05			
Gain of 253.1742 [M+H] ⁺	459.3	459.3047	460.3121	4.08	4.64E+05	3.01E+05	2.90E+05	6.74E+04	2.98E+05	3.43E+05		2.00E+05	3.07E+05	3.81E+05			2.96E+05	
Gain of 26.9408 [M+H] ⁺	233.07	233.0715	234.0788	9.76								1.35E+04						
Gain of 26.9411 [M+H] ⁺	233.07	233.0718	234.0791	9.12								1.88E+05						
Gain of 26.9412 [M+H] ⁺	233.07	233.0719	234.0792	5.32								6.05E+06						
Gain of 26.9414 [M+H] ⁺	233.07	233.0721	234.0793	5.54								2.86E+06						
Gain of 264.1357 [M+H] ⁺	470.27	470.2663	471.2736	7.93								1.40E+05						
Gain of 268.1874 [M+H] ⁺	474.32	474.3181	475.3254	4.85														
Gain of 268.1879 [M+H] ⁺	474.32	474.3184	475.3259	4.41	5.33E+05	3.39E+05	3.01E+05	1.21E+05	3.30E+05	3.21E+05		1.31E+05	3.30E+05	4.95E+05			3.47E+05	
Gain of 268.1879 [M+H] ⁺	474.32	474.3186	475.3258	4.47														
Gain of 269.1690 [M+H] ⁺	475.3	475.2997	476.307	3.9											4.12E+04			
Gain of 269.1690 [M+H] ⁺	475.3	475.2995	476.3069	4.5											4.67E+05	1.24E+06		
Gain of 269.1692 [M+H] ⁺	475.3	475.2998	476.3072	4.28	2.15E+06	1.31E+06	1.42E+06	2.79E+05	1.36E+06			7.46E+05	1.28E+06	1.67E+06				
Gain of 269.1692 [M+H] ⁺	475.3	475.2999	476.3072	4.35						1.38E+06								
Gain of 269.1694 [M+H] ⁺	475.3	475.2994	476.3074	4.08	1.78E+04		9.27E+03		9.64E+03	1.18E+04		7.44E+03		1.43E+04			1.17E+04	
Gain of 27.0679 [M+H] ⁺	233.2	233.1985	234.2059	4.86				4.09E+04			3.83E+04							
Gain of 274.1241 [M+H] ⁺	480.25	480.2548	481.262	4.5														
Gain of 274.1246 [M+H] ⁺	480.26	480.2552	481.2625	4.28	4.20E+05	2.49E+05	2.31E+05		2.39E+05		3.63E+04	1.42E+05	2.49E+05	3.68E+05			2.24E+05	
Gain of 274.1246 [M+H] ⁺	480.26	480.2553	481.2626	4.35						2.63E+05								
Gain of 283.1485 [M+H] ⁺	489.28	489.2792	490.2865	4.35										1.60E+05				
Gain of 291.2634 [M+H] ⁺	497.39	497.3939	498.4014	4.85											1.96E+05	2.33E+05		
Gain of 291.2636 [M+H] ⁺	497.39	497.3943	498.4016	4.47						1.90E+05								
Gain of 291.2641 [M+H] ⁺	497.39	497.3942	498.402	4.39	2.44E+05	1.65E+05	1.72E+05	8.50E+04	1.89E+05		7.58E+04	1.70E+05	1.93E+05	2.60E+05			1.93E+05	
Gain of 296.1682 [M+H] ⁺	502.3	502.2989	503.3061	4.69												1.62E+05		
Gain of 296.1687 [M+H] ⁺	502.3	502.2994	503.3066	4.47	3.03E+05	1.66E+05	1.71E+05		1.71E+05			1.78E+05	2.43E+05				1.53E+05	
Gain of 296.1687 [M+H] ⁺	502.3	502.2994	503.3067	4.53						1.87E+05								
Gain of 297.1277 [M+H] ⁺	503.26	503.2584	504.2657	4.65											4.32E+05			
Gain of 297.1285 [M+H] ⁺	503.26	503.2592	504.2665	4.44														
Gain of 297.2000 [M+H] ⁺	503.33	503.3306	504.3379	4.5														
Gain of 297.2002 [M+H] ⁺	503.33	503.3309	504.3382	4.28	4.34E+05	2.89E+05	2.89E+05		2.96E+05			1.93E+05	2.87E+05	3.98E+05			2.63E+05	
Gain of 297.2004 [M+H] ⁺	503.33	503.3311	504.3384	4.35						3.11E+05								
Gain of 313.1951 [M+H] ⁺	519.33	519.3258	520.333	4.27											1.61E+04			
Gain of 313.1951 [M+H] ⁺	519.33	519.3257	520.3331	4.69														
Gain of 313.1953 [M+H] ⁺	519.33	519.326	520.3333	4.53						1.23E+06					4.43E+05	1.03E+06		
Gain of 313.1954 [M+H] ⁺	519.33	519.326	520.3334	4.47	1.88E+06	1.13E+06	1.18E+06	2.21E+05	1.19E+06			6.13E+05	1.14E+06	1.47E+06			9.77E+05	
Gain of 318.1503 [M+H] ⁺	524.28	524.281	525.2883	4.69														1.95E+05
Gain of 318.1505 [M+H] ⁺	524.28	524.2812	525.2885	4.53														
Gain of 318.1507 [M+H] ⁺	524.28	524.2814	525.2887	4.47	3.81E+05	1.96E+05	1.96E+05		2.01E+05			1.11E+05	2.21E+05	3.00E+05			1.87E+05	

Table 4. Profiling results

	Neutral Mass	Average Mass	m/z	R.T. (min)	IBU	[GlyOiPr][IBU]	[AlaOiPr][IBU]	[ValOiPr][IBU]	[IleOiPr][IBU]	[LeuOiPr][IBU]	[SerOiPr][IBU]	[CysOiPr][IBU]	[MetOiPr][IBU]	[LysOiPr][IBU]	[LysOiPr][IBU] ₂	[PheOiPr][IBU]	[ProOiPr][IBU]
Gain of 327.1749 [M+H] ⁺	533.31	533.3055	534.3128	4.53										1.42E+05			1.21E+06
Gain of 329.0275 [M+H] ⁺	535.16	535.1584	536.1654	17.78										4.35E+05			
Gain of 33.9799 [M+H] ⁺	240.11	240.1106	241.1179	6.05							9.08E+04						
Gain of 330.2990 [M+H] ⁺	536.43	536.4296	537.4369	7.25												1.80E+05	
Gain of 340.1944 [M+H] ⁺	546.33	546.325	547.3323	4.84												1.06E+05	
Gain of 340.1948 [M+H] ⁺	546.33	546.3255	547.3328	4.7						1.23E+05							
Gain of 340.1952 [M+H] ⁺	546.33	546.3255	547.3331	4.64	2.00E+05	1.18E+05	1.11E+05		1.16E+05				1.17E+05	1.54E+05			1.02E+05
Gain of 341.1535 [M+H] ⁺	547.28	547.2842	548.2914	4.82										1.41E+05			
Gain of 341.1548 [M+H] ⁺	547.29	547.2855	548.2928	4.62												2.27E+05	
Gain of 341.2261 [M+H] ⁺	547.36	547.3568	548.3641	4.69						2.77E+05							
Gain of 341.2265 [M+H] ⁺	547.36	547.3572	548.3645	4.53													
Gain of 341.2266 [M+H] ⁺	547.36	547.3571	548.3645	4.47	3.91E+05	2.47E+05	2.43E+05		2.50E+05			1.45E+05	2.58E+05	3.28E+05			2.21E+05
Gain of 352.2818 [M+H] ⁺	558.41	558.4123	559.4197	7.22	2.47E+05	2.22E+05	2.10E+05	1.52E+05	2.22E+05	2.11E+05	1.63E+05	2.23E+05	2.24E+05	2.43E+05	2.10E+05		2.30E+05
Gain of 357.2212 [M+H] ⁺	563.35	563.3518	564.3591	4.29										1.44E+04			
Gain of 357.2215 [M+H] ⁺	563.35	563.3519	564.3595	4.84										1.39E+04			7.61E+05
Gain of 357.2216 [M+H] ⁺	563.35	563.3523	564.3596	4.45													
Gain of 357.2216 [M+H] ⁺	563.35	563.3523	564.3596	4.7						8.70E+05							
Gain of 357.2218 [M+H] ⁺	563.35	563.3522	564.3598	4.64	1.38E+06	8.50E+05	8.79E+05		8.52E+05			4.48E+05	8.12E+05	1.06E+06			7.14E+05
Gain of 359.2891 [M+H] ⁺	565.42	565.4203	566.427	5.29	7.52E+04		5.23E+04	5.04E+04		5.47E+04			6.02E+04	5.77E+04	8.47E+04	6.93E+04	
Gain of 359.2894 [M+H] ⁺	565.42	565.42	566.4273	5.34													7.83E+04
Gain of 359.2896 [M+H] ⁺	565.42	565.4203	566.4275	4.97											1.41E+06	1.20E+06	
Gain of 359.2897 [M+2H] ²⁺	565.42	565.4204	283.7175	5.02													
Gain of 359.2900 [M+H] ⁺	565.42	565.4206	566.428	5.1	8.32E+04	6.78E+04	5.87E+04	4.34E+04	5.98E+04	6.29E+04		6.46E+04	6.74E+04	8.89E+04			7.49E+04
Gain of 359.2901 [M+2H] ²⁺	565.42	565.4206	283.7177	4.81	3.20E+05	1.85E+05	1.87E+05	8.06E+04	1.98E+05		1.02E+05	1.92E+05	2.02E+05	3.19E+05			2.35E+05
Gain of 359.2902 [M+2H] ²⁺	565.42	565.4208	283.7177	4.86						2.08E+05							
Gain of 359.2902 [M+H] ⁺	565.42	565.4209	566.4282	4.86						1.21E+06							
Gain of 359.2903 [M+H] ⁺	565.42	565.4207	566.4283	4.79	1.56E+06	1.06E+06	1.16E+06	6.81E+05	1.27E+06		5.86E+05	1.10E+06	1.19E+06	1.69E+06	5.05E+04	6.07E+04	1.29E+06
Gain of 359.2903 [M+H] ⁺	565.42	565.4208	566.4282	5.48													
Gain of 362.1764 [M+H] ⁺	568.31	568.3071	569.3144	4.7						1.53E+05							
Gain of 362.1767 [M+H] ⁺	568.31	568.3074	569.3147	4.84													
Gain of 362.1768 [M+H] ⁺	568.31	568.3076	569.3148	4.64	2.63E+05	1.40E+05	1.34E+05		1.43E+05				1.48E+05	2.01E+05			1.27E+05
Gain of 371.2008 [M+H] ⁺	577.33	577.3315	578.3388	4.71										1.07E+05			
Gain of 381.2716 [M+H] ⁺	587.4	587.4023	588.4095	4.97											1.37E+06	1.24E+06	
Gain of 381.2722 [M+H] ⁺	587.4	587.4028	588.4102	4.81	1.61E+06	1.22E+06	1.15E+06	6.93E+05	1.23E+06		7.64E+05	1.17E+06	1.19E+06	1.57E+06			1.27E+06
Gain of 381.2723 [M+H] ⁺	587.4	587.403	588.4103	4.86						1.19E+06							
Gain of 381.2724 [M+H] ⁺	587.4	587.403	588.4103	4.92										2.54E+04			
Gain of 384.2214 [M+H] ⁺	590.35	590.3521	591.3593	4.78										8.56E+04			
Gain of 385.1797 [M+H] ⁺	591.31	591.3103	592.3176	4.97											2.48E+05		
Gain of 385.1803 [M+H] ⁺	591.31	591.311	592.3183	4.79										9.02E+04			
Gain of 385.2522 [M+H] ⁺	591.38	591.3829	592.3902	4.84													1.51E+05
Gain of 385.2528 [M+H] ⁺	591.38	591.3834	592.3908	4.64	2.62E+05	1.67E+05	1.62E+05		1.64E+05				1.67E+05	2.08E+05			1.47E+05
Gain of 385.2528 [M+H] ⁺	591.38	591.3835	592.3908	4.7						1.73E+05							

Table 4. Profiling results

	Neutral Mass	Average Mass	m/z	R.T. (min)	IBU	[GlyOiPr][IBU]	[AlaOiPr][IBU]	[ValOiPr][IBU]	[IleOiPr][IBU]	[LeuOiPr][IBU]	[SerOiPr][IBU]	[CysOiPr][IBU]	[MetOiPr][IBU]	[LysOiPr][IBU]	[LysOiPr][IBU] ₂	[PheOiPr][IBU]	[ProOiPr][IBU]
Gain of 39.1040 [M+H] ⁺	245.23	245.2349	246.242	6.21			1.88E+04								9.82E+04		
Gain of 39.1040 [M+H] ⁺	245.23	245.2347	246.242	6.55											6.77E+03		
Gain of 39.1042 [M+H] ⁺	245.24	245.235	246.2422	6.16			2.28E+04						2.33E+04				2.59E+04
Gain of 39.1045 [M+H] ⁺	245.24	245.2353	246.2424	6.08			1.11E+06		9.23E+05	1.33E+06		1.18E+06			5.60E+06	1.30E+06	
Gain of 39.1049 [M+H] ⁺	245.24	245.2352	246.2428	6.02			1.20E+06				9.69E+05		1.31E+06			1.25E+06	
Gain of 401.2475 [M+H] ⁺	607.38	607.378	608.3854	5											2.18E+05	4.46E+05	
Gain of 401.2477 [M+H] ⁺	607.38	607.3784	608.3857	4.83						4.78E+05							
Gain of 401.2479 [M+H] ⁺	607.38	607.3785	608.3858	4.78			4.91E+05		4.78E+05			2.44E+05	4.75E+05	6.22E+05			4.18E+05
Gain of 403.0463 [M+H] ⁺	609.18	609.177	610.1842	19.19													1.15E+06
Gain of 404.3478 [M+H] ⁺	610.48	610.478	611.4853	4.97											3.51E+05	3.07E+05	
Gain of 404.3481 [M+H] ⁺	610.48	610.4785	611.4858	4.86						3.18E+05							
Gain of 404.3481 [M+H] ⁺	610.48	610.4783	611.4861	4.79			3.13E+05	2.03E+05	3.38E+05								3.36E+05
Gain of 406.2031 [M+H] ⁺	612.33	612.3339	613.341	4.78													
Gain of 429.2791 [M+H] ⁺	635.41	635.4093	636.417	4.78					9.28E+04								
Gain of 429.2791 [M+H] ⁺	635.41	635.4098	636.417	4.83						9.13E+04							
Gain of 443.3831 [M+H] ⁺	649.51	649.5136	650.5211	7.24			7.83E+04				6.23E+04						
Gain of 445.2736 [M+H] ⁺	651.4	651.4043	652.4116	5.13													
Gain of 445.2740 [M+H] ⁺	651.4	651.4048	652.412	4.92			2.38E+05		2.38E+05	2.37E+05						2.20E+05	
Gain of 465.3657 [M+H] ⁺	671.5	671.4962	672.5037	7.23			1.40E+05	1.17E+05	1.39E+05	1.39E+05	1.22E+05	1.54E+05	1.50E+05	1.54E+05		1.37E+05	1.52E+05
Gain of 472.3725 [M+H] ⁺	678.5	678.5032	679.5105	5.48												2.07E+04	
Gain of 472.3728 [M+H] ⁺	678.5	678.5035	679.5108	5.34													2.54E+04
Gain of 472.3734 [M+2H] ²⁺	678.5	678.5042	340.2593	5.29											3.42E+06	2.77E+06	
Gain of 472.3735 [M+H] ⁺	678.5	678.5044	679.5115	5.29			2.10E+04	2.23E+04	2.24E+04						3.65E+06	3.24E+06	
Gain of 472.3739 [M+H] ⁺	678.5	678.5043	679.5118	4.7			1.28E+04						1.58E+04				1.76E+04
Gain of 472.3739 [M+H] ⁺	678.5	678.5046	679.5118	4.89												1.36E+04	
Gain of 472.3740 [M+H] ⁺	678.5	678.5047	679.512	4.75						1.34E+04							
Gain of 472.3743 [M+2H] ²⁺	678.5	678.505	340.2598	4.67		14700											
Gain of 472.3744 [M+H] ⁺	678.5	678.5049	679.5124	5.1			3.12E+06	2.65E+06	3.15E+06	3.24E+06	2.14E+06	3.14E+06	3.35E+06	3.95E+06			3.49E+06
Gain of 472.3749 [M+2H] ²⁺	678.5	678.505	340.2601	5.1			2.45E+06	1.70E+06	2.31E+06	2.77E+06	1.79E+06	2.77E+06	2.79E+06	3.61E+06			3.08E+06
Gain of 489.2999 [M+H] ⁺	695.43	695.4309	696.4379	5.04			1.07E+05		1.09E+05	1.07E+05			1.05E+05	1.35E+05			
Gain of 49.1247 [M+H] ⁺	255.26	255.2556	256.2627	7.23			9.90E+03	1.07E+04	9.07E+03						3.06E+04	8.09E+03	
Gain of 49.1248 [M+H] ⁺	255.26	255.2556	256.2627	7.14			1.25E+04	1.30E+04	1.02E+04	1.42E+04	1.22E+04	1.34E+04	1.25E+04		4.14E+04	1.27E+04	
Gain of 49.1254 [M+H] ⁺	255.26	255.2561	256.2633	8.23											7.11E+03		
Gain of 490.3838 [M+2H] ²⁺	696.51	696.5143	349.2645	4.3					6.40E+04								8.54E+04
Gain of 490.3839 [M+2H] ²⁺	696.51	696.5146	349.2646	4.39						6.71E+04							
Gain of 494.3556 [M+H] ⁺	700.49	700.4864	701.4936	5.29											3.88E+06	3.47E+06	
Gain of 494.3568 [M+H] ⁺	700.49	700.4869	701.4947	5.1			3.32E+06	2.76E+06	3.42E+06	3.44E+06	2.77E+06	3.56E+06	3.58E+06	4.03E+06			3.72E+06
Gain of 510.3196 [M+2H] ²⁺	716.45	716.4503	359.2324	5.34													1.32E+04
Gain of 510.3205 [M+2H] ²⁺	716.45	716.4512	359.2329	5.49											1.64E+04		
Gain of 510.3209 [M+2H] ²⁺	716.45	716.4517	359.2331	5.28			1.24E+04		9.78E+03	1.26E+04	1.30E+04		1.50E+04				2.45E+05
Gain of 510.3213 [M+2H] ²⁺	716.45	716.4519	359.2332	5.29											3.17E+05		
Gain of 510.3219 [M+2H] ²⁺	716.45	716.4521	359.2335	5.1			2.27E+05	1.45E+05	2.14E+05	2.52E+05	1.67E+05	2.51E+05	2.57E+05	3.12E+05			2.82E+05

Table 4. Profiling results

Table 4. Profiling results	Neutral Mass	Average Mass	m/z	R.T. (min)	IBU	[GlyOiPr][IBU]	[AlaOiPr][IBU]	[ValOiPr][IBU]	[IleOiPr][IBU]	[LeuOiPr][IBU]	[SerOiPr][IBU]	[CysOiPr][IBU]	[MetOiPr][IBU]	[LysOiPr][IBU]	[LysOiPr][IBU] ₂	[PheOiPr][IBU]	[ProOiPr][IBU]
Gain of 510.3288 [M+H] ⁺	716.46	716.4598	717.4667	5.1				8.53E+04			7.91E+04						
Gain of 516.3387 [M+2H] ²⁺	722.47	722.4694	362.242	5.1			4.07E+04										
Gain of 517.4309 [M+H] ⁺	723.56	723.5618	724.5689	5.29											8.51E+05	7.78E+05	8.51E+05
Gain of 517.4322 [M+H] ⁺	723.56	723.5625	724.5701	5.1				7.17E+05	7.82E+05	7.84E+05	6.45E+05	7.96E+05	8.32E+05	8.80E+05			
Gain of 55.0053 [M+H] ⁺	261.14	261.136	262.1432	11.03										2.06E+05			
Gain of 55.0991 [M+H] ⁺	261.23	261.2299	262.2371	6.18									6.10E+04			7.85E+04	
Gain of 55.0994 [M+H] ⁺	261.23	261.23	262.2373	5											2.11E+06	4.23E+05	
Gain of 55.0994 [M+H] ⁺	261.23	261.23	262.2373	6.23				7.04E+04	4.99E+04	5.15E+04	4.54E+04	6.45E+04			2.27E+05	7.13E+04	
Gain of 55.0996 [M+H] ⁺	261.23	261.2302	262.2376	4.85				4.57E+05	3.46E+05	4.52E+05	2.84E+05	4.28E+05	4.30E+05	3.97E+05			4.55E+05
Gain of 55.0997 [M+H] ⁺	261.23	261.2304	262.2377	3.9										2.30E+04			
Gain of 56.4476 [M+2H] ²⁺	773.58	773.5783	387.7964	5.33							2.80E+04						
Gain of 57.0424 [M+H] ⁺	263.17	263.1732	264.1804	0.87										1.25E+05	2.34E+05		
Gain of 57.9661 [M+H] ⁺	264.1	264.0968	265.1041	13.27				6.09E+03	2.33E+03								
Gain of 57.9664 [M+H] ⁺	264.1	264.0972	265.1044	15.68				4.24E+04									
Gain of 57.9664 [M+H] ⁺	264.1	264.097	265.1043	15.75				7.64E+04									
Gain of 57.9664 [M+H] ⁺	784.58	784.5798	785.587	7.26							4.98E+04						
Gain of 58.5456 [M+2H] ²⁺	791.59	791.5867	396.8006	5.07												2.80E+04	
Gain of 58.5456 [M+H] ⁺	791.59	791.587	792.5943	5.07												1.34E+04	
Gain of 58.5456 [M+H] ⁺	791.59	791.5879	792.595	5.49											1.84E+06	1.37E+06	
Gain of 58.5457 [M+H] ⁺	791.59	791.5888	792.5951	4.88				1.39E+04	1.14E+04	1.14E+04	1.49E+04	1.58E+04	1.58E+04				1.70E+04
Gain of 58.5457 [M+H] ⁺	791.59	791.5888	792.5952	5.32				1.46E+06	1.34E+06	1.35E+06	1.25E+06	2.11E+06	1.65E+06	1.83E+06			1.71E+06
Gain of 58.5457 [M+2H] ²⁺	791.59	791.5891	396.8015	5.49					1.40E+04								
Gain of 58.5457 [M+2H] ²⁺	791.59	791.5883	396.8016	4.89				2.66E+04	2.75E+04	2.96E+04	1.91E+04	3.35E+04	3.50E+04	1.26E+04	4.56E+06	3.62E+06	1.81E+04
Gain of 58.5457 [M+2H] ²⁺	791.59	791.5889	264.8703	5.32				2.93E+04			3.51E+04						6.91E+03
Gain of 58.5458 [M+2H] ²⁺	791.59	791.5889	396.8018	5.33				3.66E+06	3.46E+06	3.40E+06	3.24E+06	3.70E+06	4.17E+06	4.63E+06			4.27E+06
Gain of 603.4680 [M+2H] ²⁺	809.6	809.5987	405.8066	4.72												1.33E+05	
Gain of 603.4681 [M+2H] ²⁺	809.6	809.5988	405.8067	4.61						1.31E+05							
Gain of 603.4685 [M+2H] ²⁺	809.6	809.5989	405.8068	4.53				7.49E+04	1.27E+05		6.42E+04	1.56E+05	1.76E+05				1.98E+05
Gain of 607.4374 [M+2H] ²⁺	813.57	813.5681	407.7913	5.49											3.33E+05	2.88E+05	
Gain of 607.4377 [M+2H] ²⁺	813.57	813.5692	407.7914	5.33				3.05E+05	2.90E+05	2.87E+05	2.88E+05	2.82E+05	3.37E+05	3.39E+05			3.31E+05
Gain of 607.4392 [M+H] ⁺	813.57	813.57	814.5772	5.49											2.84E+06	2.26E+06	
Gain of 607.4398 [M+H] ⁺	813.57	813.5707	814.5778	5.33				2.40E+06	2.20E+06	2.21E+06	2.23E+06	2.76E+06	2.54E+06	2.81E+06			2.61E+06
Gain of 61.0863 [M+H] ⁺	267.22	267.2169	268.2242	6.03				4.41E+04			3.83E+04						
Gain of 61.9976 [M+H] ⁺	268.13	268.1283	269.1356	6.25											6.23E+04		
Gain of 61.9978 [M+H] ⁺	268.13	268.1284	269.1357	6.12											3.39E+05		
Gain of 62.3405 [M+2H] ²⁺	829.54	829.5358	415.7752	5.49											3.21E+05	2.56E+05	
Gain of 62.3406 [M+2H] ²⁺	829.54	829.5366	415.7756	5.33				2.44E+05	2.30E+05	2.33E+05	2.32E+05	2.43E+05	2.85E+05	3.17E+05			2.87E+05
Gain of 62.34131 [M+H] ⁺	829.54	829.5438	830.5511	5.32				6.35E+04									
Gain of 62.9422 [M+2H] ²⁺	835.55	835.5528	418.7837	5.48												1.49E+05	
Gain of 62.9422 [M+2H] ²⁺	835.55	835.5529	418.784	5.32				1.54E+05	1.59E+05	1.54E+05	1.63E+05			1.79E+05			
Gain of 630.5145 [M+H] ⁺	836.65	836.6462	837.6524	5.32				4.11E+05	3.90E+05	4.11E+05	3.39E+05	5.12E+05	4.29E+05	4.65E+05			4.45E+05
Gain of 630.5149 [M+H] ⁺	836.65	836.6456	837.6529	5.49											4.22E+05	3.79E+05	

	Neutral Mass	Average Mass	m/z	R.T. (min)	IBU	[GlyOiPr][IBU]	[AlaOiPr][IBU]	[ValOiPr][IBU]	[IleOiPr][IBU]	[LeuOiPr][IBU]	[SerOiPr][IBU]	[CysOiPr][IBU]	[MetOiPr][IBU]	[LysOiPr][IBU]	[LysOiPr][IBU] ₂	[PheOiPr][IBU]	[ProOiPr][IBU]
Gain of 67.1351 [M+H] ⁺	273.27	273.2658	274.2731	7.99											2.55E+04		
Gain of 67.1355 [M+H] ⁺	273.27	273.2662	274.2734	6.73											1.97E+04		
Gain of 67.1356 [M+H] ⁺	273.27	273.2663	274.2736	7.76											1.86E+04		
Gain of 67.1357 [M+H] ⁺	273.27	273.2664	274.2737	7.29			1.63E+05										
Gain of 67.1358 [M+H] ⁺	273.27	273.2666	274.2738	7.14	4.39E+06	4.74E+06	4.46E+06	5.19E+06	4.03E+06	5.03E+06	4.82E+06	5.11E+06	5.24E+06	1.97E+07	5.56E+06	5.56E+06	4.95E+06
Gain of 68.9879 [M+H] ⁺	275.12	275.1185	276.1258	9.74								1.03E+05					
Gain of 68.9881 [M+H] ⁺	275.12	275.1187	276.126	9.12								1.90E+06					
Gain of 69.1416 [M+H] ⁺	275.27	275.2724	276.2795	7.14			8.39E+04	9.33E+04		9.39E+04	8.85E+04		9.73E+04	3.66E+05	9.91E+04		
Gain of 69.5409 [M+2H] ²⁺	863.55	863.5508	453.3431	5.04	6.45E+04	6.08E+04	5.49E+04	6.07E+04	6.02E+04	5.02E+04	4.11E+04	6.37E+04	6.83E+04			7.47E+04	7.94E+04
Gain of 69.5410 [M+2H] ²⁺	904.67	904.6717	453.3431	5.52				3.36E+04			4.69E+04					6.31E+04	
Gain of 69.5415 [M+3H] ³⁺	904.67	904.6724	302.5647	5.21													
Gain of 69.5422 [M+2H] ²⁺	866.98	866.9782	453.3437	5.54	1.04E+06	7.68E+05	7.05E+05	8.83E+05	6.16E+05	6.79E+05	8.08E+05	7.76E+05	9.12E+05		2.44E+04	2.44E+04	1.07E+06
Gain of 69.5423 [M+2H] ²⁺	904.67	904.6725	453.3437	5.65										7.00E+05	8.31E+05		
Gain of 70.0415 [M+H] ⁺	276.17	276.1722	277.1794	10.81										1.47E+05			
Gain of 70.0415 [M+H] ⁺	276.17	276.1722	277.1795	11.03										8.77E+05			
Gain of 70.0416 [M+H] ⁺	276.17	276.1723	277.1795	10.36										5.21E+05			
Gain of 71.0943 [M+H] ⁺	277.22	277.225	278.2323	5.17										1.72E+05			
Gain of 71.1093 [M+H] ⁺	277.24	277.2399	278.2472	9.59							4.34E+04						
Gain of 71.6517 [M+2H] ²⁺	922.68	922.6824	462.3485	4.92												1.52E+05	
Gain of 71.6527 [M+2H] ²⁺	922.68	922.6831	462.349	4.73	2.27E+05	1.54E+05	1.51E+05	9.48E+04	1.54E+05	1.49E+05	7.76E+04	1.79E+05	1.98E+05			2.20E+05	
Gain of 72.5234 [M+2H] ²⁺	926.65	926.6542	464.3343	5.54												1.21E+05	
Gain of 72.5234 [M+2H] ²⁺	926.65	926.6542	464.3343	5.54		104000	1.04E+05	1.32E+05	9.26E+04	1.08E+05	1.19E+05	1.25E+05	1.34E+05	1.28E+05		1.50E+05	
Gain of 72.5237 [M+2H] ²⁺	926.65	926.654	464.3345	5.04	1.57E+04		7.85E+03					1.00E+04	1.07E+04			1.27E+04	
Gain of 72.5241 [M+2H] ²⁺	926.65	926.6547	464.3347	5.21												1.02E+04	
Gain of 73.1249 [M+H] ⁺	279.26	279.2555	280.2628	9.89					2.04E+04		2.62E+04			2.48E+04			
Gain of 73.6490 [M+2H] ²⁺	942.62	942.6204	472.3176	5.52				4.27E+04			4.31E+04						
Gain of 742.5057 [M+2H] ²⁺	948.64	948.6364	475.3255	5.65											2.00E+05		
Gain of 742.5059 [M+2H] ²⁺	948.64	948.6367	475.3256	5.54		191000	1.96E+05	1.93E+05			2.22E+05	1.96E+05	2.22E+05	2.27E+05		2.27E+05	
Gain of 743.5976 [M+2H] ²⁺	949.73	949.7283	475.8714	5.51				6.11E+04									
Gain of 75.1404 [M+H] ⁺	281.27	281.2711	282.2783	8.56								6.23E+03	7.14E+03				
Gain of 76.0372 [M+H] ⁺	282.17	282.1679	283.1752	3.51													
Gain of 76.0374 [M+H] ⁺	282.17	282.168	283.1754	3.35	3.71E+05	2.39E+05	2.86E+05	2.33E+05	2.33E+05	2.47E+05		1.76E+05	2.56E+05	2.50E+05		2.41E+05	
Gain of 77.0689 [M+H] ⁺	283.2	283.1996	284.2068	2.99			7.87E+04			6.39E+04			7.00E+04	6.85E+04			
Gain of 78.0314 [M+H] ⁺	284.16	284.1621	285.1694	11.42										3.52E+05			
Gain of 78.9821 [M+H] ⁺	285.11	285.1127	286.12	10.31	3.36E+05												
Gain of 81.1148 [M+H] ⁺	287.25	287.2455	288.2528	8.03											7.20E+05		
Gain of 81.6260 [M+2H] ²⁺	1017.76	1017.757	509.8856	5.7		92400										1.10E+05	1.27E+05
Gain of 81.6273 [M+2H] ²⁺	1017.76	1017.757	509.8862	5.17		41800										4.93E+04	5.95E+04
Gain of 829.6354 [M+3H] ³⁺	1035.77	1035.766	346.2626	5.06												7.66E+04	
Gain of 829.6361 [M+3H] ³⁺	1035.77	1035.766	346.2629	4.87	1.11E+05	8.45E+04		4.06E+04	6.19E+04	7.09E+04	5.07E+04	8.53E+04	9.92E+04			1.24E+05	
Gain of 829.6374 [M+2H] ²⁺	1035.77	1035.768	518.8913	4.87									1.37E+05				
Gain of 83.1300 [M+H] ⁺	289.26	289.2612	290.268	4.99					6.76E+03						7.57E+03		

Table 4. Profiling results

	Neutral Mass	Average Mass	m/z	R.T. (min)	IBU	[GlyOiPr][IBU]	[AlaOiPr][IBU]	[ValOiPr][IBU]	[IleOiPr][IBU]	[LeuOiPr][IBU]	[SerOiPr][IBU]	[CysOiPr][IBU]	[MetOiPr][IBU]	[LysOiPr][IBU]	[LysOiPr][IBU] ₂	[PheOiPr][IBU]	[ProOiPr][IBU]
Gain of 83.1302 [M+H] ⁺	289.26	289.2609	290.2681	5.95											1.06E+04		
Gain of 83.1304 [M+H] ⁺	289.26	289.2611	290.2684	5.06											4.56E+03		
Gain of 83.1306 [M+H] ⁺	289.26	289.2615	290.2686	6.2		5.21E+05	4.12E+05		3.74E+05	4.72E+05		4.68E+05		2.85E+06	4.77E+05		
Gain of 83.1306 [M+H] ⁺	289.26	289.2613	290.2686	7.28		3.05E+05	4.02E+05	2.79E+05	2.99E+05	2.99E+05	3.02E+05	3.51E+05	3.35E+05	1.50E+06	3.55E+05	3.68E+05	
Gain of 83.1308 [M+H] ⁺	289.26	289.2615	290.2688	6.15				4.47E+05			3.61E+05		4.48E+05			4.72E+05	
Gain of 83.1309 [M+H] ⁺	289.26	289.2616	290.2689	5.14										5.20E+03			
Gain of 85.5888 [M+2H] ²⁺	1061.72	1061.72	531.867	5.67				5.49E+04			7.11E+04						
Gain of 87.0680 [M+H] ⁺	293.2	293.1987	294.206	10.81											4.36E+05		
Gain of 88.0522 [M+H] ⁺	294.18	294.1828	295.1901	9.16											7.52E+05		
Gain of 89.1174 [M+H] ⁺	295.25	295.2483	296.2553	7.14		79700	7.11E+04		8.59E+04	8.72E+04			1.04E+05		3.16E+05	1.16E+05	
Gain of 92.0233 [M+H] ⁺	298.15	298.154	299.1613	10.36											8.20E+04		
Gain of 92.0233 [M+H] ⁺	298.15	298.154	299.1613	10.81											2.25E+05		
Gain of 92.9878 [M+H] ⁺	299.12	299.1185	300.1258	9.02							2.13E+05						
Gain of 93.0636 [M+H] ⁺	299.19	299.1942	300.2015	3.51												1.02E+05	
Gain of 93.0638 [M+H] ⁺	299.19	299.1944	300.2018	3.35		1.47E+05	1.14E+05		8.90E+04	9.44E+04			9.93E+04	9.55E+04		9.22E+04	
Gain of 94.2720 [M+3H] ³⁺	1148.85	1148.85	383.9575	5				3.03E+04			3.86E+04						
Gain of 95.1305 [M+H] ⁺	301.26	301.2611	302.2684	8.23											4.14E+05		
Gain of 98.0191 [M+H] ⁺	304.15	304.1498	305.157	3.51												1.33E+05	
Gain of 98.0192 [M+H] ⁺	304.15	304.1499	305.1572	3.35		1.94E+05	1.30E+05		1.10E+05	1.24E+05		8.53E+04	1.30E+05	1.35E+05		1.26E+05	
Gain of 99.1254 [M+H] ⁺	305.26	305.256	306.2634	6.29						1.99E+04					2.73E+05		
Gain of 99.1257 [M+H] ⁺	305.26	305.2563	306.2636	5.17						9.26E+04	5.70E+04				6.67E+05	9.61E+04	
Gain of 99.1258 [M+H] ⁺	305.26	305.2562	306.2637	5.04													
Gain of 99.1263 [M+H] ⁺	305.26	305.257	306.2642	4.98										8.80E+04			
Glucuronidation [M+NH ₄] ⁺	382.16	382.3882	400.1965	6.59					7.20E+03	1.45E+04							
Glucuronidation [M+NH ₄] ⁺	382.16	382.3795	400.1967	7.55					1.64E+04								
Glycine Conjugation [M+H] ⁺	263.15	263.2983	264.1585	5.48								5.45E+03					
Glycine Conjugation [M+NH ₄] ⁺	263.15	263.3112	281.1857	4.76										5.37E+03			
Isopropyl to Acid [M+H] ⁺	208.07	208.073	209.0805	5.48		7.00E+04		5.51E+03									
Isopropyl to Acid [M+H] ⁺	208.07	208.0732	209.0805	7.1		1.62E+04											
Isopropyl to Acid [M+H] ⁺	208.07	208.0742	209.0815	13.5													9.42E+02
Isopropyl to Acid [M+H] ⁺	208.07	208.0728	209.0801	15.75													3.48E+03
Ketone Formation [M+H] ⁺	220.11	220.1092	221.1167	4.5						3.53E+03							4.28E+03
Ketone Formation [M+H] ⁺	220.11	220.1093	221.1167	5.27		3.87E+03			5.22E+03	1.60E+04	6.15E+03	8.57E+03	1.53E+04				
Ketone Formation [M+H] ⁺	220.11	220.1094	221.1167	5.41												6.91E+03	
Ketone Formation [M+H] ⁺	220.11	220.1093	221.1165	9.16											2.76E+04		
Ketone Formation [M+H] ⁺	220.11	220.1094	221.1166	9.7											3.12E+03		
Ketone Formation [M+H] ⁺	220.11	220.1097	221.1169	10.36											7.12E+05		
Ketone Formation [M+H] ⁺	220.11	220.1095	221.1168	10.81											3.90E+05		
Ketone Formation [M+H] ⁺	220.11	220.1093	221.1166	10.87											1.36E+05		
Ketone Formation [M+H] ⁺	220.11	220.1093	221.1166	11.03											8.67E+04		
Ketone Formation [M+NH ₄] ⁺	220.11	220.1096	238.1434	11.03											9.12E+03		
Loss of 10.9869 [M+H] ⁺	195.14	195.1438	196.151	9.89				3.88E+04			4.00E+04						

Table 4. Profiling results

	Neutral Mass	Average Mass	m/z	R.T. (min)	IBU	[GlyOiPr][IBU]	[AlaOiPr][IBU]	[ValOiPr][IBU]	[IleOiPr][IBU]	[LeuOiPr][IBU]	[SerOiPr][IBU]	[CysOiPr][IBU]	[MetOiPr][IBU]	[LysOiPr][IBU]	[LysOiPr][IBU] ₂	[PheOiPr][IBU]	[ProOiPr][IBU]
Loss of 13.1097 [M+H] ⁺	193.02	193.021	194.0283	5.32								1.35E+05					
Loss of 13.1098 [M+H] ⁺	193.02	193.0209	194.0281	5.54								6.58E+04					
Loss of 14.0888 [M+H] ⁺	192.04	192.0419	193.0492	4.6						5.54E+04							
Loss of 15.1057 [M+H] ⁺	191.02	191.025	192.0323	5.32								2.79E+06					
Loss of 15.1057 [M+H] ⁺	191.03	191.025	192.0323	5.54								1.38E+06					
Loss of 16.1721 [M+H] ⁺	189.96	189.9586	190.9659	6.91						6.53E+04							
Loss of 2.0783 [M+H] ⁺	204.05	204.0524	205.0596	5.44										1.71E+05			
Loss of 24.0600 [M+H] ⁺	182.07	182.0706	183.0779	5.44										8.45E+05			
Loss of 29.1902 [M+H] ⁺	176.94	176.9405	177.9478	0.66			2.55E+05										
Loss of 29.1902 [M+H] ⁺	176.94	176.9405	177.9477	0.91			5.03E+04										
Loss of 4.0317 [M+H] ⁺	202.1	202.099	203.1063	11.03											3.74E+05		
Loss of 4.0318 [M+H] ⁺	202.1	202.0989	203.1061	10.81											1.00E+05		
Loss of 4.9222 [M+H] ⁺	201.21	201.2085	202.2158	6.04			3.40E+04										
Loss of 41.0520 [M+H] ⁺	165.08	165.0786	166.0859	4.28												2.38E+05	
Loss of 46.0422 [M+H] ⁺	160.09	160.0885	161.0958	11.03													
Loss of 46.0425 [M+H] ⁺	160.09	160.0882	161.0955	10.81													
Loss of 47.1321 [M+H] ⁺	159	158.9986	160.0059	5.99													
Loss of 52.0915 [M+H] ⁺	154.04	154.0392	155.0464	5.44													
Loss of 58.1149 [M+H] ⁺	148.02	148.0157	149.0231	4.14		23700			2.18E+04								1.98E+04
Loss of 6.9377 [M+H] ⁺	199.19	199.193	200.2002	9.91		322000		2.16E+05	3.98E+05								2.77E+05
Loss of 6.9379 [M+H] ⁺	199.19	199.1927	200.2	4.61								1.42E+06					4.71E+03
Loss of 61.1112 [M+H] ⁺	145.02	145.0195	146.0268	5.32								7.30E+05					
Loss of 61.1112 [M+H] ⁺	145.02	145.0195	146.0268	5.54								9.44E+04					
Loss of 65.1426 [M+H] ⁺	140.99	140.988	141.9953	5.98													
Loss of 76.9790 [M+H] ⁺	129.15	129.1515	130.159	0.62		26300				2.16E+04		5.16E+04					2.20E+05
Loss of 87.0576 [M+H] ⁺	119.07	119.0731	120.0804	4.28												1.51E+05	
Loss of CO [M+H] ⁺	178.13	178.1349	179.1422	6.96								4.77E+03					
Loss of CO [M+H] ⁺	178.14	178.1355	179.1427	7.15								5.81E+03					
Loss of Hydroxymethylene [M+H] ⁺	176.12	176.1195	177.1267	6.49								3.94E+04					
Loss of Hydroxymethylene [M+H] ⁺	176.12	176.1197	177.1271	6.96		1.56E+04			1.24E+04								1.20E+04
Loss of Hydroxymethylene [M+H] ⁺	176.12	176.1195	177.1268	8.07								2.52E+04					
Loss of O+2-(4-(2-formyl-1,1-dihydroxy-3-oxopropyl)phenyl)propanoic acid [M+H] ⁺	250.08	250.0836	251.0909	7.08													
Loss of O+2-(4-(2-formyl-1,1-dihydroxy-3-oxopropyl)phenyl)propanoic acid [M+H] ⁺	250.08	250.0836	251.0908	7.86													
Loss of O+2-(4-(2-formyl-1,1-dihydroxy-3-oxopropyl)phenyl)propanoic acid [M+H] ⁺	250.08	250.0839	251.0911	7.92													
Loss of O+Bis-Ketone Formation [M+H] ⁺	218.09	218.0939	219.1012	7.04													
Loss of O+Bis-Ketone Formation [M+H] ⁺	218.09	218.0932	219.1005	7.13													
Loss of O+Bis-Ketone Formation [M+H] ⁺	218.09	218.0935	219.1008	7.42													
Loss of O+Bis-Ketone Formation [M+H] ⁺	218.09	218.0941	219.1014	7.9													
Loss of O+Bis-Ketone Formation [M+H] ⁺	218.09	218.0933	219.1006	8.74												4.25E+03	
Loss of O+Bis-Ketone Formation [M+H] ⁺	218.09	218.0932	219.1005	15.88													1.77E+03

Table 4. Profiling results

	Neutral Mass	Average Mass	m/z	R.T. (min)	IBU	[GlyOiPr][IBU]	[AlaOiPr][IBU]	[ValOiPr][IBU]	[IleOiPr][IBU]	[LeuOiPr][IBU]	[SerOiPr][IBU]	[CysOiPr][IBU]	[MetOiPr][IBU]	[LysOiPr][IBU]	[LysOiPr][IBU] ₂	[PheOiPr][IBU]	[ProOiPr][IBU]
Loss of O+Demethylation and Desaturation [M+H] ⁺	174.1	174.1041	175.1114	5.27						1.05E+04	3.48E+03	6.11E+03	9.65E+03				
Loss of O+Demethylation and Desaturation [M+H] ⁺	174.1	174.1039	175.1112	8.4	1.50E+04												
Loss of O+Demethylation and Desaturation [M+H] ⁺	174.1	174.1039	175.1112	9.16										3.90E+03			
Loss of O+Demethylation and Desaturation [M+H] ⁺	174.1	174.1041	175.1114	10.36										2.94E+03			
Loss of O+Demethylation and Desaturation [M+H] ⁺	174.1	174.1037	175.111	10.72	6.69E+03												
Loss of O+Demethylation and Desaturation [M+H] ⁺	174.1	174.104	175.1113	10.81										1.15E+04			
Loss of O+Demethylation and Desaturation [M+H] ⁺	174.1	174.104	175.1113	11.03										2.30E+04			
Loss of O+Di-Hydrogenation [M+NH ₄] ⁺	194.17	194.1669	212.2008	3.64			1.01E+04										
Loss of O+Ethyl Ether to Acid [M+H] ⁺	176.08	176.0832	177.0905	5.65	8.49E+03												
Loss of O+Ethyl Ether to Acid [M+H] ⁺	176.08	176.0832	177.0905	6.53	1.36E+04												
Loss of O+Ethyl Ether to Acid [M+NH ₄] ⁺	176.08	176.0835	194.1173	0.61										1.93E+03			
Loss of O+Ethyl Ether to Acid [M+H] ⁺	164.08	164.083	165.0903	5.44										2.19E+04			
Loss of O+Ethyl Ether to Acid [M+H] ⁺	164.08	164.0833	165.0906	6.81										9.59E+03			
Loss of O+Ethyl Ether to Acid [M+H] ⁺	164.08	164.083	165.0903	6.88										1.73E+04			
Loss of O+Glutamine Conjugation [M+NH ₄] ⁺	318.19	318.5035	336.2287	9.88							4.97E+03			5.82E+03			
Loss of O+Glutamine Conjugation [M+NH ₄] ⁺	318.2	318.4871	336.2293	11.28								9.98E+03	1.53E+04				
Loss of O+Glycine Conjugation [M+NH ₄] ⁺	247.16	247.2832	265.1914	6.02											1.33E+04		
Oxidation [M+H] ⁺	222.13	222.1253	223.1323	6.49	8.40E+03							1.52E+04					
Oxidation [M+H] ⁺	222.13	222.1252	223.1327	6.96	1.91E+04							1.30E+04	2.80E+04	5.87E+03	1.50E+04	1.46E+04	2.09E+04
Oxidation [M+H] ⁺	222.12	222.1247	223.132	7.44								5.53E+03					
Oxidation and Glutamine Conjugation [M+NH ₄] ⁺	350.19	350.3664	368.2192	6.33					1.23E+04			1.30E+04					
Oxidation and Glutamine Conjugation [M+NH ₄] ⁺	350.19	350.4064	368.2195	6.39											1.24E+04		
Oxidation and Glutamine Conjugation [M+NH ₄] ⁺	350.19	350.3924	368.2192	11.42													4.79E+03
Oxidation and Sulfate Conjugation [M+NH ₄] ⁺	302.08	302.2825	320.1163	7.74								1.78E+04					
Oxidation and Taurine Conjugation [M+H] ⁺	329.13	329.3142	330.1358	4.61								5.86E+03					
Parent [M+H] ⁺	206.13	206.1302	207.1374	9.39												1.80E+04	
Parent [M+H] ⁺	206.13	206.1306	207.1378	13.2													
Parent [M+H] ⁺	206.13	206.1313	207.1386	15.71													
Phosphorylation [M+H] ⁺	286.1	286.0984	287.1057	9.01								9.49E+03					
Propyl Ether to Acid [M+H] ⁺	178.06	178.0623	179.0695	7.63	2.13E+04												
Propyl Ether to Acid [M+H] ⁺	178.06	178.0622	179.0695	8.34	1.80E+04												
Propyl Ether to Acid [M+H] ⁺	178.06	178.0625	179.0698	10.72	8.42E+04												
Propyl Ketone to Acid [M+H] ⁺	166.06	166.0634	167.0707	14.63													
S-Cysteine Conjugation [M+H] ⁺	325.13	325.313	326.1414	6.12												8.25E+02	
Tetra-Oxidation and Demethylation [M+NH ₄] ⁺	256.09	256.095	274.1288	2.51	1.27E+04												

Table 4. Profiling results