

Modelling and simulation of a system for verticalization and aiding the motion of individuals suffering from paresis of the lower limbs

K. BAGIŃSKI, D. JASIŃSKA-CHOROMAŃSKA*, and J. WIERCIAK

Institute of Micromechanics and Photonics, Faculty of Mechatronics, Warsaw University of Technology,
8 Św. A. Boboli St., 02-525 Warszawa, Poland

Abstract. There has been designed a device for verticalization and aiding the gait of individuals suffering from paresis of the lower limbs. It can be counted in the category of so-called “wearable robots”, whose task is to replace or aid human limbs. Dependently on the function realized, these robots are classified into one of the following three groups:

- a) exoskeletons – strengthening the force of human muscles beyond their natural abilities,
- b) orthotic robots – restoring lost or weakened functions of human limbs,
- c) prosthetic robots – replacing an amputated limb.

A significant feature of the device that has been designed is the fact that it has not to replace human limbs, but only restore them to their lost motor capabilities. Thus, according to the presented classification, it is an orthotic robot. Unlike in the case of the existing systems for verticalization, the gait is to be realized in a way that is automatic to the highest possible extent, keeping the user involved as little as possible, and the device is to imitate the natural movements of man with the highest fidelity.

Within the works on the system for verticalization and aiding the motion, a simulation model of the device was created. It includes a structure of the robot, a model of the actuators and a model of the human body that constitutes the load for the driving units. Then, simulation studies were carried out, including evaluation of the power demand of the device as well as the influence of the gait rate and of the length of the steps on the operation of the system.

Key words: orthotic robots, actuators, modelling, simulations.

1. Introduction

The orthotic robot that has been designed within an ECO-Mobility project and is intended for verticalization and aiding the motion of persons suffering from paresis of the lower limbs. In particular, it is to realize activities of walking, sitting down and getting up as well as going up and down the regular stairs. Because the device co-acts with a living organism which is a human body, the robot must be safe for the user, first of all. Hence, it was necessary to carry out detailed model studies of the system that has been designed. Their aim is to simulate the interaction between the robot and the human body as accurately as possible, and thus make it possible to assess the behavior of the body affected by the acting forces, whose source will be the robot.

The simulation model is also a very useful tool that allows one to foresee, having assumed certain simplifications, functioning of the built system without a necessity of performing complicated computations or manufacturing a physical model of the device. It provides a lot of possibilities of studying the power demand, simulating thermal phenomena taking place at the driving units or studying dynamics of the human-orthotic robot system. It also allows one to carry out an identification of the loads that occur during the gait, and thus significantly simplifies the process of selecting appropriate driving units. Additionally, the simulation studies allow

one to optimize the mechanical structure of the system that has been designed with regard to the power efficiency, its weight and velocity or fidelity of reconstructing the motion. During the design works, one must make a lot decisions that will influence operation of the system. The following exemplary problems can be listed: a necessity of determining a position of mounting the power supply and the driving units, selection of the most advantageous weight of the device, the gait rate or length of the steps. The created simulation model essentially simplifies the related decision process, owing to a possibility of changing particular parameters and evaluating the influence of these changes on the operation of the system. The Matlab/Simulink/Simmechanics software was chosen as the modelling environment.

2. Methodology of modelling the system for verticalization and aiding the motion

2.1. Kinematic structure. The elaborated model consists of two independent structures: a model of the human body and a model of the device for aiding the motion (Figs. 1, 2). The models are connected by means of viscoelastic elements, what on one hand allows them to be displaced with respect to one another, and on the other hand ensures a certain rigidity of this coupling, and thus makes the human body passively follow the movements of the robots.

*e-mail: danuta@mchtr.pw.edu.pl

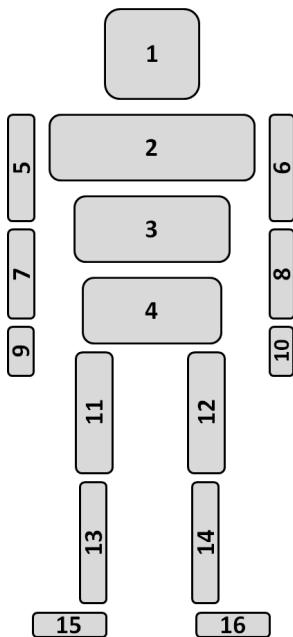

Fig. 1. Structure of the 16-element model of the human body; 1 – head and neck, 2 – upper part of the trunk, 3 – middle part of the trunk, 4 – lower part of the trunk, 5 – left arm, 6 – right arm, 7 – left forearm, 8 – right forearm, 9 – left palm, 10 – right palm, 11 – left thigh, 12 – right thigh, 13 – left shin, 14 – right shin, 15 – left foot, 16 – right foot

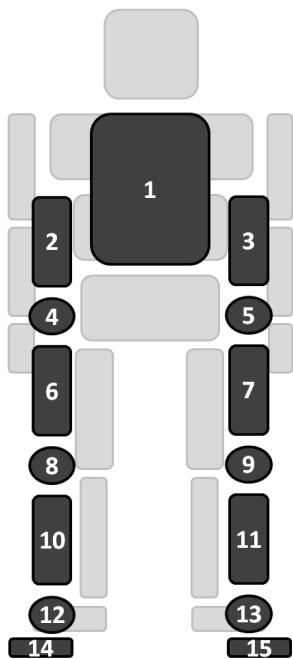

Fig. 2. Elements included in the model of the orthotic robot (against a model of the human body); 1 – backpack, 2 – coupler of the left trunk, 3 – coupler of the right trunk, 4 – articulation of the left hip, 5 – articulation of the right hip, 6 – coupler of the left thigh, 7 – coupler of the right thigh, 8 – articulation of the left knee, 9 – articulation of the right knee, 10 – coupler of the left shin, 11 – coupler of the right shin, 12 – articulation of the left ankle joint, 13 – articulation of the right ankle joint, 14 – sole of the left foot, 15 – sole of the right foot

The model of the human body is to ensure a variable static and dynamic load with respect to the mechanical structure and the actuators of the device for aiding the gait (Fig. 3).

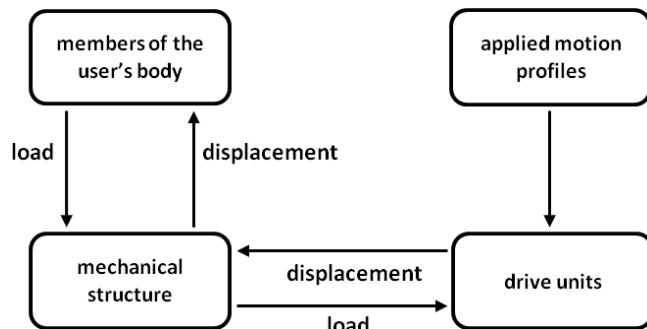

Fig. 3. Schematic of the simulation model

Kinematic structure of the model of the human body. The human body was divided into sixteen parts (Fig. 1), and each of them has its own mass, length, mass moment of inertia with respect to the three axes of the coordinate system, position of the center of gravity. The mentioned values were determined on the basis of the data provided in the related literature [1, 2]. For the sake of simplicity, it was accepted that the upper limbs are immobile.

The body parts are represented in the model by rigid solids. It must be underlined that it is a significant simplification compare to the natural properties of the human body, since bones and joints are in fact not perfectly rigid.

Connections between successive body segments at the hip joint and the ankle joint are provided by single-axis articulations. The knee joint was modeled as a four-bar linkage, for such solution ensures a better reconstruction of the motion trajectory of the natural joint compare to a case when a single-axis articulations are used.

Kinematic structure of the model of the robot. The model of the robot includes a backpack mounted on the user's trunk which imitates a portable power supply. Each leg of the robot consists of three couplers of the joints which are the main elements of the mechanical structure of the robot. The couplers make it possible to fix to them the drive units, to connect them with the user's body and to transmit motion from the drives to the man (Fig. 2). The couplers are fastened to articulations located in the axis of the natural joints. The desired values of the rotation angle, velocity and acceleration of the rotary motion in the articulations of the device at the knee and the hip joint are realized by means of a model of a DC motor, independent for each of the mentioned joints. Changes of the weights of the couplers and of the positions of their centers of gravity make it possible to analyze behavior of the device for various arrangements of the drives with respect to the couplers, as well as in the case of changing the drives for new ones having a different weight.

Coupling of the elements of the robot and the man. Two independent models: the model of the orthotic robot and the model of the human body should be interconnected in order

to transmit the loads generated by the body parts through the mechanical structure of the robot into the modeled drive units. On the other hand, the drive units through the elements of the robot are to force movement of the body parts (Fig. 3).

In the case of the existing similar devices, such as orthoses, exoskeletons or orthotic robots, in order to obtain a physical coupling between the robot and the man, leather or textile straps are used most frequently, since they ensure a strong yet relatively elastic coupling. An excessive pressure on the human limbs cannot be allowed, since that could impede the blood circulation or have a bad influence on the nervous system. Therefore, while building the model, one undertook also an attempt of employing such coupling that would feature properties similar to elastic catches. Application of viscoelastic elements at the coupling made it possible to obtain the assumed flexibility of the coupling. Additionally, such solution makes it possible to regard the elasticity of the human muscles and skin, as well as dislocations of the muscles due to the applied force. Each coupler was connected with a corresponding body part by means of two catches, what in total yields six straps on the left and another six on the right side of the device. Results of the simulation studies proved that it is a satisfactory number of couplings, ensuring that the robot co-acts with the man in a correct way, provided the parameters of the elastic elements are selected in an appropriate way.

2.2. Realization of the motion. Planes of motion. The simulation model was adapted to realize the gait function within the sagittal plane only (Fig. 4). The main reason for accepting such simplification is the fact that the device will force a motion within this plane only, because of the necessity of minimizing its dimensions and energy consumption.

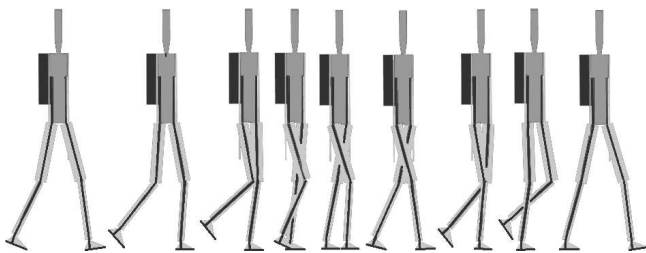

Fig. 4. Part of the visualization of the gait simulation

At the stage of initials studies, the created model had also the trunk movements limited to the sagittal plane only, with no possibility of any turns about an axis perpendicular to this plane. As a result, the trunk keeps a stable position, perpendicular to the ground.

Drive units. The model of the orthotic robot includes a modeled drive unit in a form of a DC motor coupled with a gear. The motor operates in a feedback loop that makes it follow a set value (Fig. 5). Each of the driven joints has a separate subsystem setting a desired value of the angle at a joint in a form of a cyclic function (Fig. 6). The task of the PID controller is to control the voltage supplied to the motor in such a way that the value of the angular displacement at the articulation

is as close to the desired value as possible. Calculation of the current input at the motor and the supply voltage makes it possible to determine the electric energy consumed by a given drive.

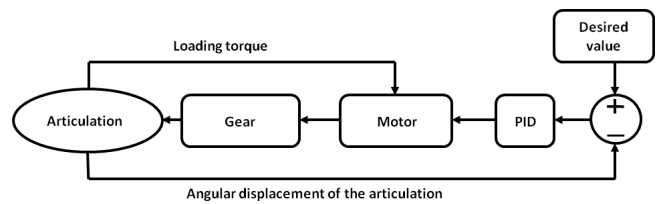

Fig. 5. Block diagram of the control loop for the drive unit of the articulation of the device

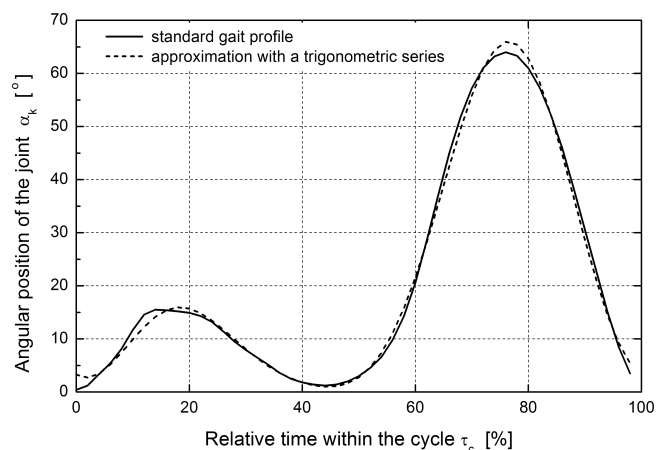

Fig. 6. Standard profile of the bending angle at the knee joint and its approximation with the Fourier series

The desired values used in the control loop of the actuators were obtained owing to examinations of the gait function in the case of healthy persons. Only for such persons the standard gait trajectories have been determined. The obtained experimental data were approximated with mathematic functions, using a fast Fourier transform (FFT), which made it possible to convert the experimental data in a form of time series into trigonometric series of various forms. This method is very suitable for description of cyclic functions, thus it was chosen for approximation of the functions reconstructing the human motion. As far as the project is concerned – especially the model studies, it was decided to present results of the approximations in a form of a cosine series:

$$f(t) = A_0 + \sum_{n=1}^m A_n \cos(2\pi n f_0 t + \varphi_n), \quad (1)$$

where n – harmonic number, m – total number of harmonics, f_0 – basic frequency, A_0 – amplitude of the constant component, t – time, A_n – amplitude of the n -th harmonic, φ_n – phase shift of the n -th harmonic.

While creating a model of loads of the actuators, it is necessary to create also models of the units themselves. At the present stage of the works, two elements of the actuators of the robot were taken into account, i.e. a DC motor and a gear, since these are very significant elements as far as the

load model is concerned. In the case of drive units with rotary motion, mathematical model of motion takes a form of an equation of equilibrium of the torques

$$(J_s + J_{red}) \frac{d^2 \varphi_s}{dt^2} + K_D \frac{d\varphi_s}{dt} + (M_f + M_{fred}) \operatorname{sgn} \left\{ \frac{d\varphi_s}{dt} \right\} + M_{red} = M_s, \quad (2)$$

where J_s – mass moment of inertia of the rotor of the motor, J_{red} – mass moment of inertia of the driven elements referred to the motor shaft, K_D – coefficient of viscous resistances to motion, M_s – torque of the motor, M_{red} – active torque of the load referred to the motor shaft, M_f – internal moment of friction of the motor, M_{fred} – frictional load torque referred to the motor shaft, φ_s – rotation angle of the motor shaft.

The reduction gear is modeled in simulation programs according to the formula [3]

$$\omega_{mech} = \frac{\omega}{i_p}, \quad (3)$$

where ω_{mech} – angular velocity of the output shaft of the gear, ω – angular velocity of the input shaft of the gear.

At the same time, it is assumed that both position and efficiency of such gear are constant in time. In fact, it is not the case, and both of these quantities vary in function of the rotation angle. As far as the realized model works are concerned, the assumption concerning the constancy in time of these quantities is satisfactory, and there is no need to regard errors resulted from non-constancy of the ratio and the efficiency.

Application of a reduction gear results not only in a change of the angular velocity, but reduction of the torques and the mass moments of inertia as well,

$$M_{Fred} = \frac{M_{Fmech}}{\eta_p i_p}, \quad (4)$$

$$J_{red} = \frac{J_{mech}}{i_p^2}, \quad (5)$$

where M_{Fmech} – moment of friction in the mechanism, M_{Fred} – reduced moment of friction in the mechanism, i_p – ratio of the gear, J_{mech} – mass moment of inertia of the driven elements of the mechanism, J_{red} – reduced mass moment of inertia of the driven elements of the mechanism, η_p – efficiency of the gear.

Reduction of the active torques has two forms, depending on the direction in which the active torque acts:

– when active torque M_{mech} acts in the direction opposite to the direction of torque of the motor, it is reduced according to the following formula

$$M_{red} = \frac{M_{mech}}{\eta_p i_p} (\operatorname{sgn}\{M_{mech}\} = -\operatorname{sgn}\{M_s\}), \quad (6)$$

– when the torque acts with accordance to the direction of torque of the motor, it is described as follows

$$M_{red} = \frac{M_{mech} \cdot \eta_p}{i_p} (\operatorname{sgn}\{M_{mech}\} = \operatorname{sgn}\{M_s\}). \quad (7)$$

Period of the gait. An initial, empirically accepted value of the cycle period was assumed to be of 4 s. A respective parameter introduced in the model allows this value to be optionally changed and then allows simulations to be executed for various gait rates. However, it must be emphasized that a change of the length of the gait cycle does not influence the length of the steps reconstructed by the model. It influences only the rate of performing the same movements, i.e. reconstructing the standard gait profiles in the joints at various rates.

The used standard values of the angles at the joints and the accepted height of the user (1.7 m) result in the fact that one full gait cycle corresponds to a length of 1.26 m. Hence, the gait with the length of the cycle period of 4 s corresponds to a motion with a velocity of ca. 1.13 km/h.

Parameterization with respect to the anthropometric features.

The orthotic robot is to be designed for a possibly wide circle of the end-users. Therefore, it is necessary to evaluate the influence of individual features of the users on the operation of the man-robot system. In the case of the created model, it is possible to quickly change parameters related to the masses and lengths of the involved elements. It allows simulation studies to be carried out that evaluate the influence of changing chosen anthropometric features on the operation of the system that has been designed. The chosen anthropometric features which became parameters in the present version of the model are height and weight of the user. A change of the user's height results in an automatic adjustment of the model of the robot according to an implemented algorithm. In a similar way, a change of the user's total weight results in a new recalculation of all the parameters related to the masses of the model of the human body according to regression equations taken from the related literature. Such solution significantly simplifies and accelerates the process of model studies with respect to individual anthropometric features. As the model will be developed in the future, it is foreseen to take into consideration also other individual features, besides the height and the weight, which would allow the simulation of the operation of the device to be as precise as possible.

The accepted simplifications. In the created model, one used gait profiles at the joints obtained while examining the gait of healthy individuals. However, these are results averaged over gait measurements of many persons having various build. According to the theory pertaining to the gait, 10% of the gait period at the beginning and the end of the cycle should be a phase of a double support. That requirement turned out to be impossible to meet in the described model. The reason is surely limiting the motion to the sagittal plane only. Should the other degrees of freedom be actuated, a phase of the double-support might be achieved. Lack of this phase results in an unnatural character of the gait that is visible during the simulation since only one leg provides the support, and it resembles more a run than a gait. Additionally, supporting the whole body on one leg only, at the moment when it is tilted the most, results in a significant increase of the torque at the joints, because the whole load resulted from the weight

of the user's body and the weight of the device is transmitted by a single limb. Should the phase of the double support be achievable, the weight were distributed to two limbs for some period of time within the gait cycle. However, a positive aspect is that due to the lack of this phase of gait, during the real operation of the device the torques will be most probably lower than the obtained by means of the current simulations.

A second simplification assumed is disregarding in the simulations that have been carried out hitherto a friction between the elements of the device and the human body. In fact, the model contains blocks allowing values of the static, Coulomb and viscous friction to be determined, however they will be used only when one determines the necessary force pressing the couplers to the limbs and the friction coefficient between the couplers material and the clothes.

2.3. Creating the thermal model of the drives. Thermal phenomena taking place during operation of the motors influence both the environment and the user. The model of the drive units has been therefore expanded as to study the thermal phenomena. It allows one to foresee in an approximate way if the increased temperatures of a given drive during its operation will not pose a threat to the safety of the user or the environment, because of the contact of the system with the human body. To calculate increments of the temperature of the motors a two-element model was used which is applied in the case of motors with coreless rotors [4]. It assumes that the thermal structure of such motor can be modeled as a system of two homogeneous bodies, one characterizing the rotor unit and the other the stator unit. As far as this model is concerned, it is additionally assumed that a phenomenon of transmitting the heat from the rotor to the environment does not take place. A diagram of the applied model is presented in Fig. 7.

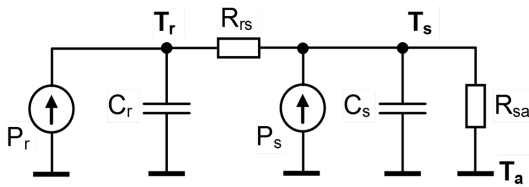

Fig. 7. Diagram of the thermal structure of the micromotor with a coreless rotor, Ref. 5; C_r – thermal capacity of the rotor, C_s – thermal capacity of the stator, P_r – thermal power generated in the rotor, P_s – thermal power generated in the stator, R_{rs} – thermal resistance between the rotor and the stator, R_{sa} – thermal resistance between the stator and the ambient, T_r – temperature of the rotor, T_s – temperature of the stator, T_a – temperature of the ambient

Additionally, it is assumed that thermal power P_r generated in the rotor is equal to power P_v representing winding losses

$$P_r = P_v = i^2 R_t, \quad (8)$$

where i – motor current, R_t – resistance of the rotor winding, and there are no heat sources in the stator:

$$P_s = 0. \quad (9)$$

Because of a change of the resistance of the windings due to increase of the rotor temperature, resistance R_t was accepted according to the Ohm's law as,

$$R_t = R_o(1 + \alpha \Delta T), \quad (10)$$

where R_o – nominal resistance of the rotor windings, α – temperature coefficient of the resistance of copper, $\Delta T = T_r - T_0$ – difference between the rotor temperature and the nominal one.

A series character of the system (Fig. 7) allows equivalent dynamic parameters to be introduced in a form of thermal time-constants: τ_s of the stator and τ_r of the rotor

$$\tau_s = C_s R_{sa}, \quad (11)$$

$$\tau_r = C_r R_{rs}, \quad (12)$$

as well as instantaneous power W to be calculated, which is given up by the rotor and transmitted to the stator, according to

$$W = \frac{(T_r - T_s)}{R_{rs}}. \quad (13)$$

Having regarded the above relations, a system of equations describing the analyzed model takes the following form,

$$\tau_r \frac{dT_r}{dt} + (T_r - T_s) = R_{rs} P_r, \quad (14)$$

$$\tau_s \frac{dT_s}{dt} + (T_s - T_a) = R_{sa} W. \quad (15)$$

In the simulation model, to actuate the motion in the hip and the knee joint, models of DC motors were applied with parameters corresponding to EC60 – 167131 motor by Maxon company. The manufacturer provides the following values of the coefficients necessary for the studies of the thermal phenomena of the drive:

$$R_{sa} = 1.3 \text{ K/W},$$

$$R_{rs} = 0.5 \text{ K/W},$$

$$\tau_s = 1200 \text{ s},$$

$$\tau_r = 33.7 \text{ s},$$

$$T_0 = 20^\circ \text{C},$$

$$R_0 = 1.03 \Omega,$$

and other values of the coefficients were accepted as follows,

$$\alpha = 0.0038 \text{ K/W},$$

$$T_a = 20^\circ \text{C}.$$

When values of the four thermal coefficients: time-constants τ_r and τ_s as well as resistance R_{rs} and R_{sa} are known, it is possible to use the above model, and thus to foresee, by the way of computations, increases of the temperature of the motor elements that take place during its operation.

It should be noted that catalog values of the parameters provided above, are only approximate and refer to a case when the motor is surrounded by stagnant air and is not in contact with other bodies. In fact, these conditions will not be met, what will have resulted in a difference between the model studies and the real heat flow. A diagram of the thermal simulation model is presented in Fig. 8.

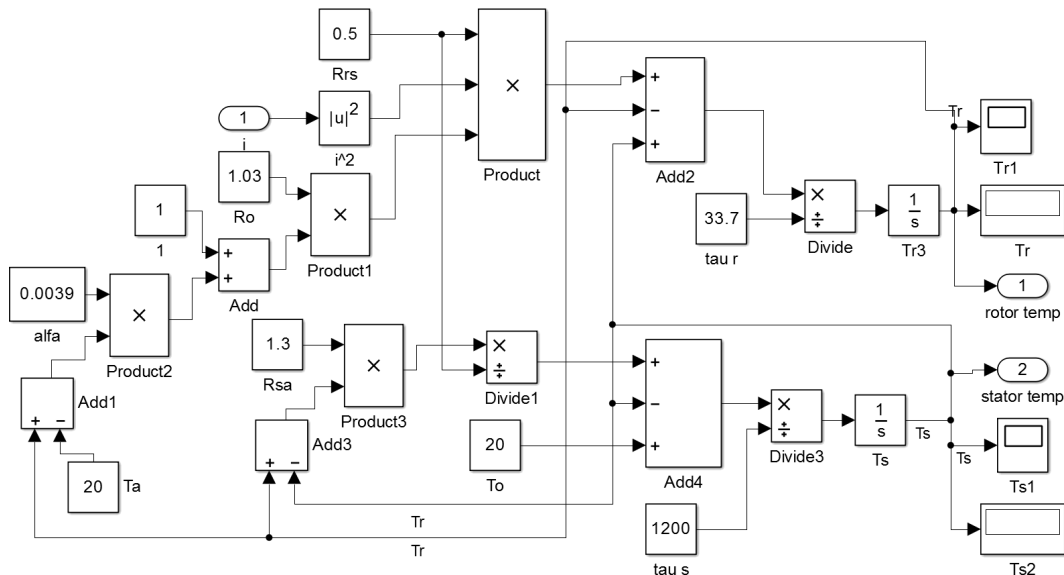

Fig. 8. Diagram of the subsystem for determining temperature increments of the drive units

3. Results of the studies

Design works on the device for verticalization and aiding the motion require making lot of decisions at various stages of the design process, regarding the shape of the mechanical structure, its mass, selection and spatial configuration of the drives, or choosing an appropriate power source. All these decisions must be based on a detailed analysis related to application of the considered solution, and on weighing resultant advantages and disadvantages. The system that has been designed is an intricate device and thus it must be expected that a choice of particular solutions will not be unequivocally positive or negative in any case. Rather, the problems will require optimization with regard to many variables. The task of the created simulation model is, among other things, to make it possible to evaluate influence of various design solutions on parameters that are significant with regard to the requirements related to the robot.

For simulation studies, Maxon EC 60 motor was used. It was used both for driving the knee articulation as well as the hip of both limbs. At the hip joint, the motor has been coupled with a reduction gear with a ratio of $i = 250$, whereas at the knee joint with a ratio of $i = 150$.

3.1. Influence of the gait rate. Values of the torques at the articulations of the device. The first part of the studies included determination of the values of the torques generated at the knee articulation (Fig. 9) and the hip articulation (Fig. 10) during a gait at various rates. Changes of the rate were realized by performing simulation for lengths of the period of the gait cycle within the interval of 2–8 s, changing the period with a step of 0.5 s. Because of the fact that the model contains a lot of viscoelastic elements, the obtained graphs and instantaneous values of the torques were so noisy, that they were almost useless for a further analysis. Therefore, they were subjected to filtering by a low-pass filter with a time-constant of 0.005 s, as to separate the real load from high frequency peeks, whose source are elastic elements (Fig. 11). A similar

effect can be surly obtained by significantly decreasing the time step of the simulation. The calculation was realized at the articulations of the device and corresponded to the value of the maximal torques that must be transmitted by the respective drive units.

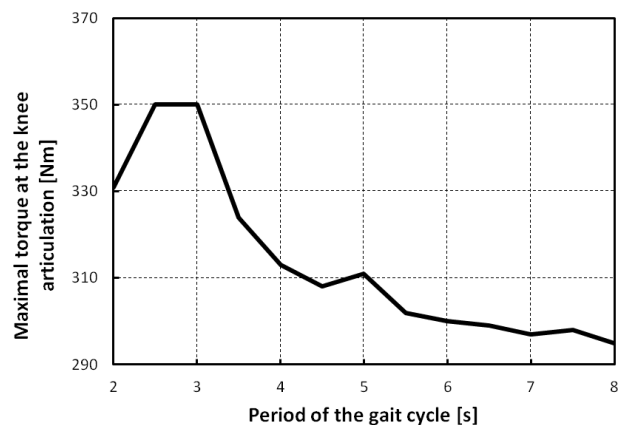

Fig. 9. Graph representing dependence of the maximal torque at the knee articulation on the length of the period of the gait cycle

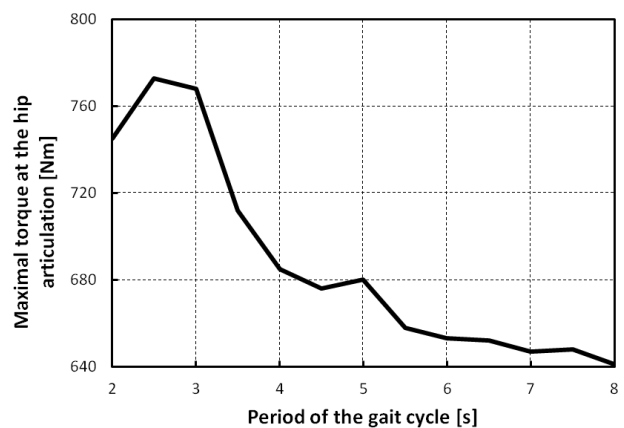

Fig. 10. Graph representing dependence of the maximal torque at the hip articulation on the length of the period of the gait cycle

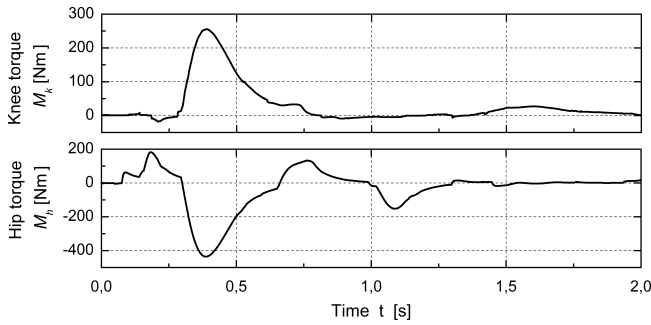

Fig. 11. Courses representing values of the torques at the knee articulation (upper curve) and the hip articulation (lower curve) after low-pass filtering (period of the gait cycle $T_0 = 2$ s)

The obtained results of the studies related to the influence of the gait rate on the value of the maximal torques at the device articulation indicate that lengthening the period of the gait cycle results in decreasing the torques. It is the case due to lower rates of the body parts as well as lower accelerations they are subjected to. That results in a smaller influence of the moments of inertia of the elements of the system due to their lower accelerations and decelerations.

Energy consumption. Energy consumption by the system at the present stage of creation of the simulation model includes only calculation of the energy supplied to the driving units. It does not regard a need of supplying the control system, the safety systems or systems responsible for communication with the user. Nevertheless, at this stage of works, they are a significant hint with regard to a possibility of influencing the power demand of the device. It is just the drives, as the main receiver of the current, that will be significantly responsible for the time of operation of the device on a single power source. The studies were carried out, as in the previous section, for the periods of the gait cycle within the interval of 2–8 s. The obtained results are presented as a graph in Fig. 12.

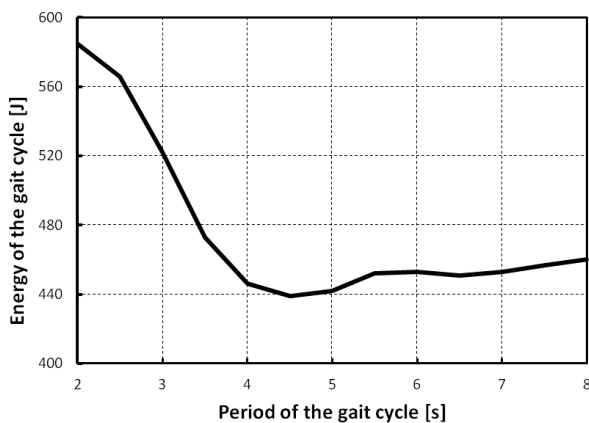

Fig. 12. Graph representing dependence of the power demand of the drive units on the gait rate

The results obtained owing to the simulations revealed a strong dependence of the length of the period of the gait cycle on the consumption of the electric power by the system for aiding the gait. The highest power demand occurred for the period of the gait within the interval of 2–3.5 s, what results

in a large measure from the values of the torques at the joints being dependent on the gait rate, determined in the previous section. Increase of the values of the torques along with speeding up the gait, results in a higher energy consumption by the drive units. However, it is the character of variations of the energy supplied to the system, as the length of the period changes, that is significant. So, for the length of the period within the range of 4–5 s, the power demand reached the lowest values, whereas by further slowing down of the gait these values started to slightly increase.

It is noteworthy that the energy consumption decreased despite the operation time of the device lengthened as far as the gait was slowed down. This proves that the most advantageous, with respect to minimization of the power demand, is to force a gait with the length of the period of ca. 4.5 s.

Error of reconstructing the gait profiles. One of the essential requirements set for the device for aiding the gait is to reconstruct the natural gait of a man as much as possible. In order to meet that requirement, one performed measurements of the angles at the joints during a gait of a healthy man. Then, the obtained values were used for controlling the angles at the articulations of the device. It was assumed that a precise reconstruction of the values of the angles of a standard gait profile by the articulation will result in achieving a gait with a trajectory that is close to the natural one. Since fidelity of the gait is a very important criterion while selecting elements of the system, so one carried out studies on influence of the gait rate on the fidelity of reconstruction of the standard gait profiles by the articulations of the device (Fig. 13). The results presented below show that only in the case of the shortest periods of the gait cycle (i.e. 2–2.5 s) the angular errors at the articulations of the joints are significant. In the case when the period was longer than 3 s, values of these errors were as small as hundredths of a degree arc, i.e. were negligible. The results obtained for $T_0 = 2$ and $T_0 = 2.5$ s suggest a necessity of using either smaller values of the ratios or motors of higher power, since the errors reached their maximums for the biggest accelerations in the joints. Then, the drive unit was not able to follow up the standard gait profile that quickly varied.

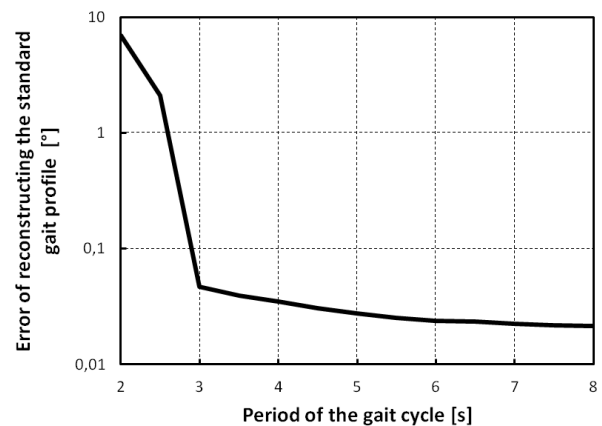

Fig. 13. Graph representing dependence of the gait rate on the error of reconstructing the standard gait profile at the hip articulation

3.2. Simulation studies of the thermal model of the drives.

The created thermal model was used for determining temperature of the elements of the drive units while realizing the gait function. The studies were carried out for the length of the gait cycle of $T = 3$ s and the length of the taken steps $l = 0.5$ m. The used mass parameters of the body parts related to a man of the height $h = 1.7$ m and mass of 70 kg. The obtained results are presented in a form of graphs in Fig. 14 for the motor actuating the motion at the hip joint and in Fig. 15 for the motor actuating the motion at the knee joint. Time of the simulation was 200 minutes, what corresponds to a case when the user walks a distance of 2 km. After this time, temperatures both of the rotor as well as the stator can be considered steady.

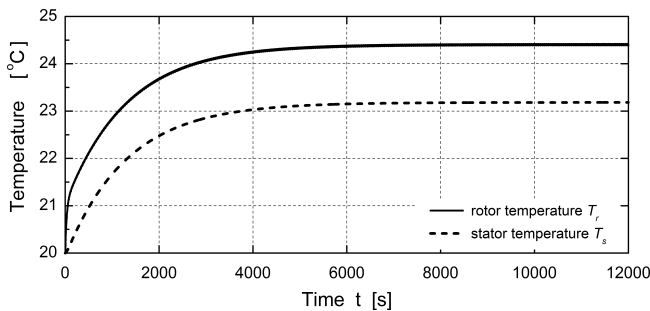

Fig. 14. Graph of the temperature increments in the drive of the knee articulation

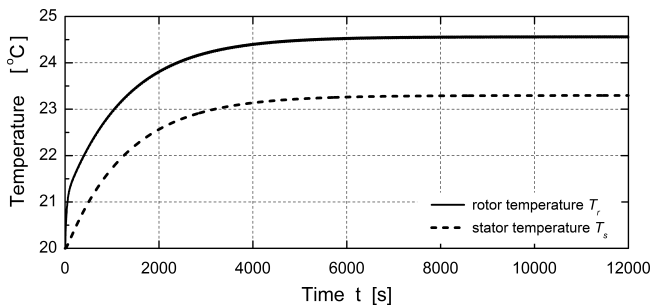

Fig. 15. Graph of the temperature increments in the drive of the hip articulation

4. Discussion

4.1. Power demand. In the literature related to orthotic robots and exoskeletons, the matter of the power demand of such systems has not been taken up so far. Numerous papers deal with the problem of building the mechanical structure [5–8] and the control system [9–12], whereas the authors do not precise the methodology of selecting the actuators. When designing autonomous walking machines one of essential problems is to assure the highest possible energy efficiency of locomotion [13]. There is a lot of coefficients that influence the energy consumption of such devices. Yet, there are no detailed studies describing their influence on the power demand of an orthotic robot. Nevertheless, from the point of view of a designer of such device, this is a very important information, that already at the stage of initial design works makes it possible to evaluate e.g. an approximate time of operation of the device for a given capacity of the energy source, in the

cases of users characterized by various weight, height, the gait rate or the extent of the performed activities. The authors of [7], while selecting the actuators, point to a high energy consumption by pneumatic systems and very high by hydraulic systems, however do not provide numerical values for specific applications. The task of the created simulation model is to facilitate selection of actuators that are appropriate for the device that has been designed. In order to do that, the model allows values of the torques at the successive joints to be calculated, as to determine the velocity of their motion at a desired gait rate, and then to determine the energy consumed by the studied actuators.

Results of initial simulation studies are presented in the respective sections (Subsec. 3.1).

4.2. Torques at the articulations . The described simulation model of the device for aiding the gait is created for determining, among other things, values of the torques transmitted by the articulations of the device. At the same time, they constitute a load for the modeled actuators. Because of an additional mass introduced by the elements of the system, the way of attaching them to the body of a handicapped person and errors in reconstructing the standard gait profiles at the joints, values of these torques are different compare to those transmitted by the joints of healthy individuals during the gait. In the literature related to analysis of the gait [1, 14–17] the authors usually focus on analysis of the kinematics of the gait and studying the torques transmitted by the joints of healthy persons. Because of that, there is no data useful for comparison of the obtained results of the simulation studies determining values of the torques transmitted by the articulations of the device.

Within the works that have been carried out, one performed simulations for various gait rates and studied its influence on the values of the determined maximal torques. The obtained results prove that decreasing the gait rate, while keeping a constant length of the step, makes it possible to achieve smaller values of the maximal torques at the articulations, what reveals the influence of the accelerated and decelerated masses on the values of the torques transmitted by the articulations.

4.3. Error of reconstructing the gait profiles. The task of the system that has been designed is a faithful imitation of the gait of a healthy man. It was assumed that it will be achieved owing to reconstructing the standard gait profiles in the joints by the drives. Because of a necessity of ensuring an elastic coupling of the elements of the orthotic robot with the human body and with regard to the fact that human muscles and skin will be deformed as a result of such coupling, it seems obvious that the angular values set for the actuators are not equal the values that occur in the joints of the user. Thus, a problem arises that is related to errors of reconstructing the gait – errors connected with a difference of angular angles at the articulations of the device and at the joints of the user. The studies performed by means of the simulation model allowed one to determine the influence of the gait rate on the

value of these errors. The model makes it possible to study an influence of many other parameters, as e.g. the rigidity of the applied coupling, spatial configuration of the couplings, mass of the device or the user's height on the resultant angular errors. In the literature related to designing exoskeletons one may find reports on studies illustrating the differences between angular movements of the joints and the articulations [18], yet they cannot be compared with the obtained results because of the accepted way of controlling the BLEEX robot, so-called *master-slave* control, where a very significant matter is the value of the delay of the robot motion (slave) with respect to the motion of a body part (master).

5. Conclusions

In the related literature, there is no description of the ways of modelling orthotic robots, whereas the presented initial simulation studies of the model point out that it is worthwhile to carry out such studies. For they make it possible to evaluate an influence of many factors, as e.g. the weight of the user, the gait rate or the length of the taken steps, on the operation of the device. The presented initial simulation studies, already at this stage, provide important information pertaining to the matter of the power demand of the drives, the maximal torques which the device will have to transmit or the fidelity of reconstructing the natural human gait. A possibility of fast adaptation of the model to specific design solutions makes it also possible to quickly verify various variants of the structure of the device with regard to their usefulness and particular requirements. Carrying-out of such simulation studies allows one to specify directions of development of the robot design and to simplify the choice of the solutions that are the most convenient, e.g. with respect to the power demand of the system.

The created initial model revealed that the main problem is not the modelling of the device itself, but determining values of the loads acting upon the actuators, whose source is the user's body. They influence the results obtained owing to the simulation studies the most, thus while creating the model, attention was mainly focused on an attempt of modelling values of the man-originated loads. At the present stage, the model features some shortcomings resulting from the accepted simplifications and the limitations of the used software itself, however that will be improved as far as the future works are concerned.

A continuation of the work is focused on development of the model in such a way as to achieve values of the loads acting upon the actuators, as close to the real values as possible. In order to do that, it is planned to activate motion also within the frontal and transverse plane, yet without adding additional actuators realizing a motion within these planes. An important stage of developing the model of the orthotic robot will be also creation of a gait model corresponding to going on crutches. Ultimately, the user of the device that has been designed will be responsible for keeping his balance while walking. The most simple way of achieving that is to ensure additional points of support, which will be the crutch-

es. Because of the fact that going on crutches differs from a natural gait and results in a change of the gait profiles at the joints, tilt angle of the trunk as well as the forces transmitted by the joints, its realizations in a form of a model results in a necessity of modifying the realized algorithms of motion.

Achieving a phase of a double-support seems to be an extremely important issue related to the development of the model. At present, the gait is forced only within the sagittal plane using the measurement data obtained for healthy individuals. These measurements were realized within three planes, therefore only combining together the movements within all the three planes would allow one to reconstruct by the model a gait that is close to the natural one, i.e. including the phase of a double-support. Meanwhile, in the built orthotic robot only the joints within the sagittal plane will be driven, and thus it seems necessary to adapt the standard gait profiles within the sagittal plane in such a way as to achieve the aforementioned phase of the gait cycle.

The performed simulation studies demonstrate possibilities of making use of the modelling while designing a device for verticalization and aiding the motion. In many cases, simulation studies are sufficient for determining an influence of changes of some parameters such as dimensions or masses of the elements of the device, what significantly simplifies the process of selecting the component elements of the actuators. The comprehensive evaluation of technical solutions selected on the basis of the presented model will require the simultaneous use of performance as well as exploitation criteria. The example of such an approach applied for assessment of the parallel kinematics structure is presented in [19].

It is foreseen that the works on the model of the system will be continued as far as implementation of the aforementioned changes is concerned.

Acknowledgements. The presented works have been carried out within the ECO-Mobility project No. UDA-POIG.01.03.01-14-154/09-00 supported by the European Union.

REFERENCES

- [1] J.L. Pons, *Wearable Robots: Biomechatronic Exoskeletons*, John Wiley & Sons, Chichester, 2008.
- [2] T. Bober and J. Zawadzki, *Biomechanics of the Human Motion System*, BK Publishing House, Wrocław, 2000, (in Polish).
- [3] W. Oleksiuk, *Selected Problems of the Design of Precision Instruments*, WPW, Warsaw, 1975, (in Polish).
- [4] W. Pełczewski, *Thermal Problems in Electric Machines*, PWT, Warsaw, 1956, (in Polish).
- [5] M. Dollar and H. Herr, "Lower extremity exoskeletons and active orthoses: challenges and state-of-the-art", *IEEE Trans. on Robotics* 24 (1), 144–158 (2008).
- [6] R. Bogue, "Exoskeletons and robotic prosthetics: A review of recent developments", *Industrial Robot: Int. J.* 36, 421–427 (2009).
- [7] F. Casalo, S. Cinquemani, and M. Cocetta, "On active lower limb exoskeleton actuator", *Proc. 5th Int. Sym. Mechatronics and its Applications* 1, CD-ROM (2008).

- [8] Zoss, H. Kazerooni, and A. Chu, "On the mechanical design of the berkeley lower extremity exoskeleton (BLEEX)", *IEEE/RSJ Int. Conf. Intelligent Robots and Systems* 1, 3465–3472 (2005).
- [9] D. Ames, R. Vasudevan, and R. Bajcsy, "Human-data based cost of bipedal robotic walking", *Proc. 14th Int. Conf. Hybrid Sys.: Computation and Control* 1, 153–162 (2011).
- [10] J. W. Grizzle, C. Chevallereau, A.D. Ames, and R.W. Sinnet, "3D bipedal robotic walking: models, feedback control, and open problems", *IFAC Symp. on Nonlinear Control Systems (NOLCOS)* 1, CD-ROM (2010).
- [11] H. Kazerooni, J.-L. Racine, L. Huang, and R. Steger, "On the control of the berkeley lower extremity exoskeleton (BLEEX)", *Proc. IEEE Int. Conf. Robotics and Automation* 1, 4353–4360 (2005).
- [12] P. Shi, Y. Zhang and X. Yang, "Lower extremity exoskeleton control and stability analysis based on virtual prototyping technique", *Proc. Int. Conf. Computer Science and Software Engineering* 1, 1131–1134 (2008).
- [13] T. Zielińska, "Autonomous walking machines-discussion of the prototyping problems", *Bull. Pol. Ac.:Tech.* 58 (3), 443–451 (2010).
- [14] D.A. Winter and L.A. Gilchrist, "A multisegment computer simulation of natural human gait", *IEEE Trans. on Rehabilitation Engineering* 5 (4), 290–299 (1997).
- [15] D.A. Winter and J.J. Eng, "Kinetic analysis of the lower limbs during walking: what information can be gained from a three-dimensional model?", *J. Biomechanics* 28 (6), 753–758 (1995).
- [16] S.-H. Pyo, A. Özer, and J. Yoon, "A novel design for lower extremity gait rehabilitation exoskeleton inspired by biomechanics", *Int. Conf. Control, Automation and Systems* 1, 1806–1811 (2010).
- [17] L. Vaughan, B.L. Davis, and J. C.O'Connor, *Dynamics of Human Gait*, Kiboho Publishers, Cape Town, 1999.
- [18] H. Kazerooni, R. Steger, and L. Huang, "Hybrid control of the Berkley Lower Extremity Exoskeleton (BLEEX)", *Int. J. Robotics Research* 25 (5–6), 561–573 (2006).
- [19] M. Ceccarelli, G. Carbone, and E. Ottaviano, "Multi criteria optimum design of manipulators", *Bull. Pol. Ac.: Tech.* 53 (1), 9–18 (2005).